

NOT FOR
CONSTRUCTION

911 Central Parkway N., Suite 425 San Antonio, TX 78323
501 North Broadway, St. Louis, Missouri 63102-2121

AIR FORCE CENTER FOR ENGINEERING AND THE ENVIRONMENT (AFCEE)

FACILITIES DYNAMIC PROTOTYPES DESIGN FOR SECURITY FORCE OPERATIONS BUILDING

100% DESIGN

November 18, 2011

SHEET LIST	
Sheet Number	Sheet Name
A-101	Police Service & Installation Security/ S5
A-102	Guardmount/Armory
A-103	Mobility/Supply
A-104	ECC/ BDOC
A-105	Training/Quality
A-106	Confinement
A-107	Investigation/ S2
A-108	Command/ Orderly
A-109	Back of House Restrooms & General Support
A-110	Break Room & Front of House Restrooms
A-111	Operations & Training/ S3
A-201	Building Rendering 1 - Rendering
A-202	Building Example 1 - Floor Plan
A-203	Building Example 2 - Rendering
A-204	Building Example 2 - Floor Plan
A-205	Building Example 2 - Floor Plan
A-301	Room Finish Schedule
A-302	Room Finish Schedule
A-303	Door Schedule
A-304	Window Schedule



AIR FORCE CENTER FOR ENGINEERING AND
THE ENVIRONMENT (AFCEE)
FACILITIES DYNAMIC PROTOTYPES DESIGN FOR:
SECURITY FORCE OPERATIONS BUILDING
100% DESIGN

Jacobs Project No.: FDWD0262

Drawing Title:

Cover Sheet

Date: 18 NOVEMBER 2011

Designed By: JNMRB/OF Drawing No.:

Drawn By: JNMRB/OF





Checked By: JS

G-000





GENERAL NOTES

1. EVERY WALL IS GENERIC UNLESS SPECIFICALLY NOTED
2. EVERY WALL IS A PLACE HOLDER
3. AS THE MODULES ARE COMBINED TO CREATE A FACILITY, DISCRETION SHOULD BE USED AS TO WHICH WALLS NEED TO BE MOVED, ADDED OR REMOVED
4. IF NO WALL IS PRESENT, IT IS THE DESIGN INTENT TO LEAVE THAT SPACE OPEN TO ADJACENT SPACES WITHIN THE FACILITY
5. ALL FURNITURE IS A PLACE HOLDER UNLESS SPECIFICALLY NOTED
6. ALL MODULES HAVE BEEN ORGANIZED BASED ON A 15' GRID.

FLOOR FINISH LEGEND

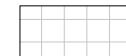
-  CARPET
-  EPOXY PAINT
-  SEALED CONCRETE
-  VCT TILE
-  CERAMIC TILE

CEILING LEGEND

-  2X2 ACOUSTICAL TILE
-  PAINTED GYP. BOARD
-  CONCRETE
-  SECURED GYP. BOARD

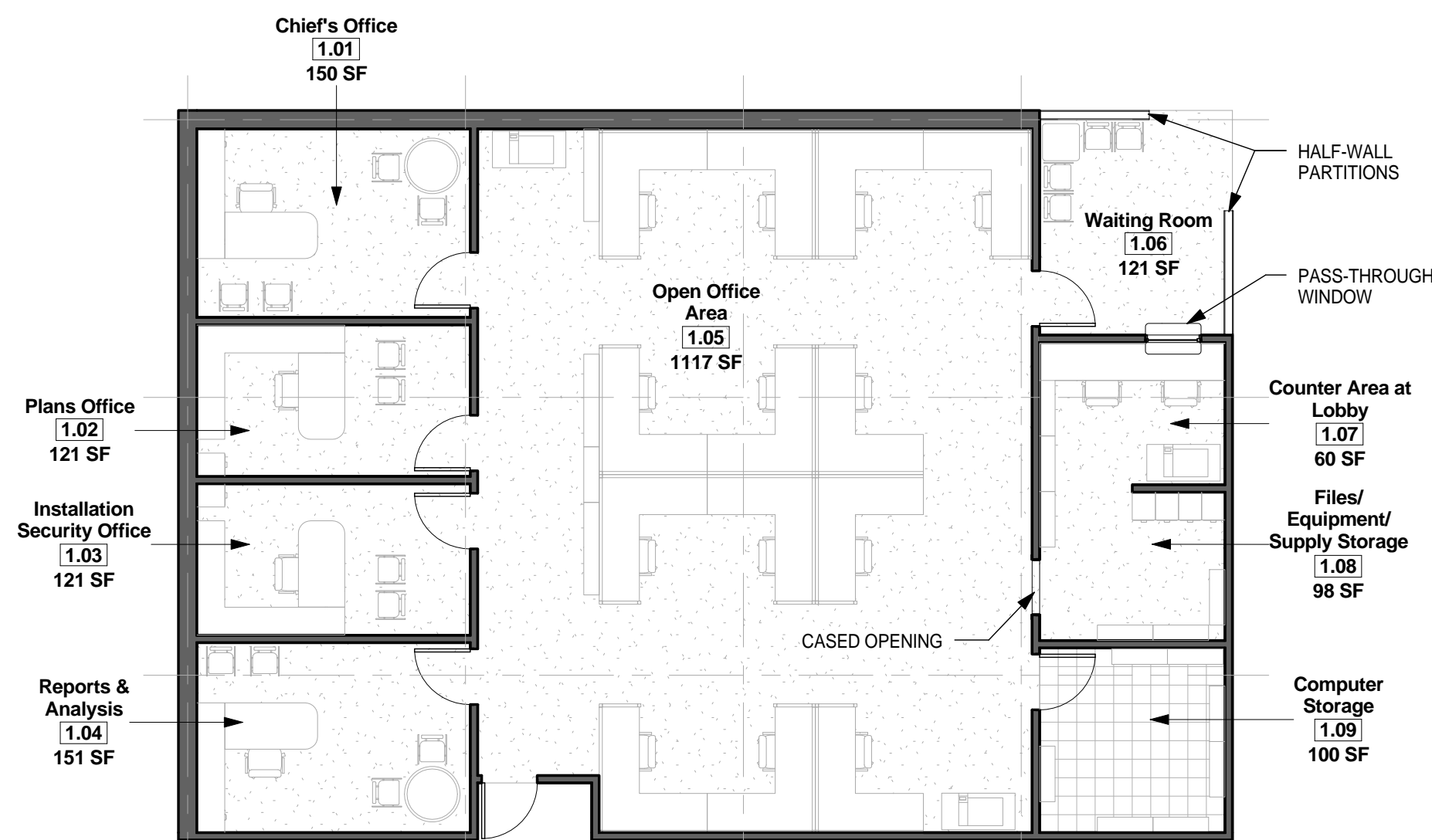

① Module 1 - Police Service & Installation Security/ S5 - Floor Plan
1/8" = 1'-0"

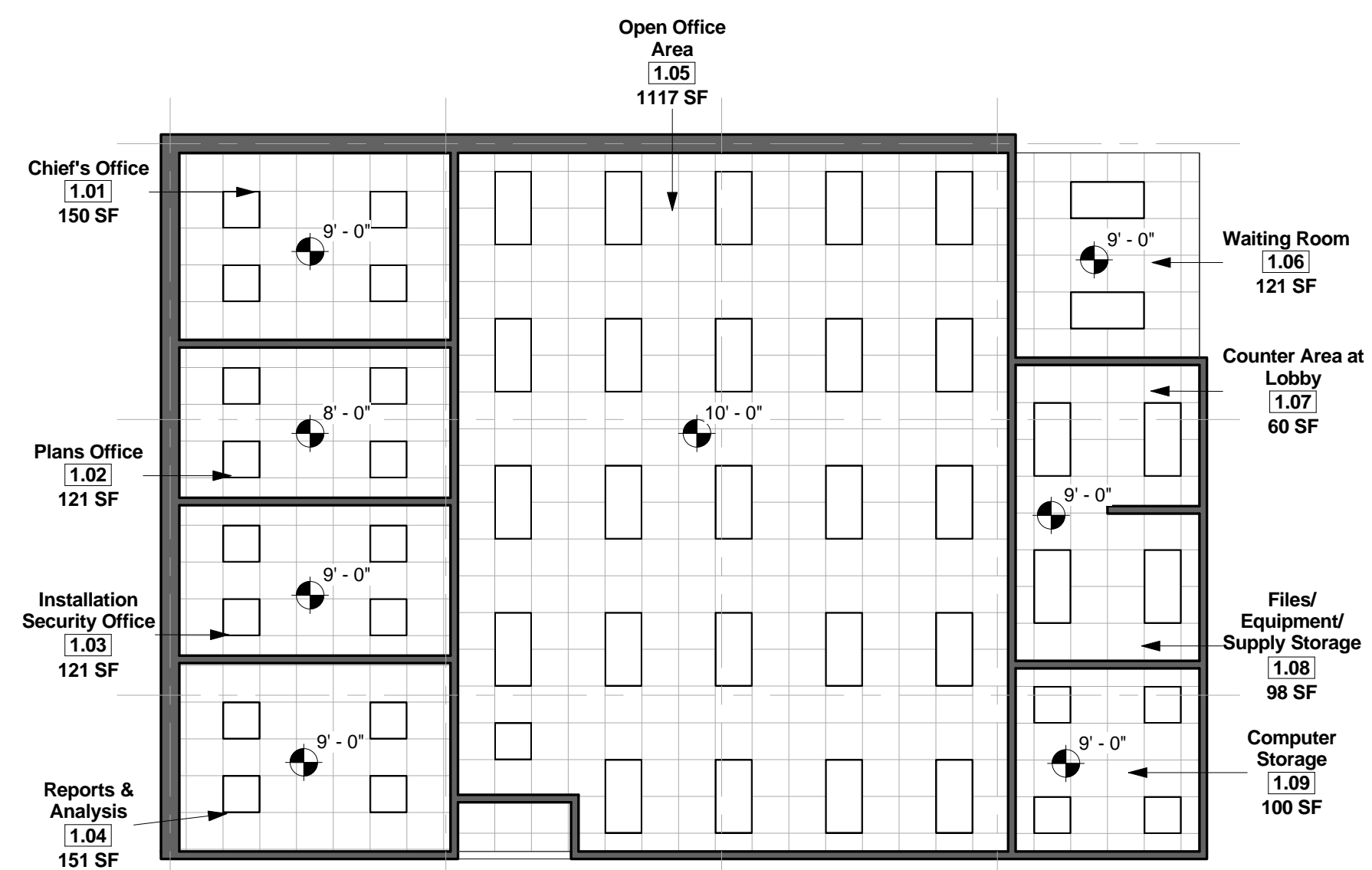

② Module 1 - Police Station & Installation Security/ S5 - Reflected Ceiling Plan
1/8" = 1'-0"



③ Module 1 - Police Service & Installation Security/ S5 - Axon.

**AIR FORCE CENTER FOR ENGINEERING AND
THE ENVIRONMENT (AFCEE)
FACILITIES DYNAMIC PROTOTYPES DESIGN FOR:
SECURITY FORCE OPERATIONS BUILDING
100% DESIGN**

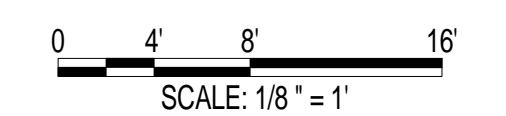

Jacobs Project No.: FDWD0262

Drawing Title:

**Police Service &
Installation Security/
S5**

Date: 18 NOVEMBER 2011

Designed By: JNM/RB/OF Drawing No.:





Drawn By: JNM/RB/OF

Checked By: JS



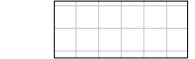

GENERAL NOTES

1. EVERY WALL IS GENERIC UNLESS SPECIFICALLY NOTED
2. EVERY WALL IS A PLACE HOLDER
3. AS THE MODULES ARE COMBINED TO CREATE A FACILITY, DISCRETION SHOULD BE USED AS TO WHICH WALLS NEED TO BE MOVED, ADDED OR REMOVED
4. IF NO WALL IS PRESENT, IT IS THE DESIGN INTENT TO LEAVE THAT SPACE OPEN TO ADJACENT SPACES WITHIN THE FACILITY
5. ALL FURNITURE IS A PLACE HOLDER UNLESS SPECIFICALLY NOTED
6. ALL MODULES HAVE BEEN ORGANIZED BASED ON A 15' GRID.

FLOOR FINISH LEGEND

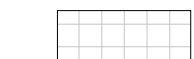
-  CARPET
-  EPOXY PAINT
-  SEALED CONCRETE
-  VCT TILE
-  CERAMIC TILE

CEILING LEGEND

-  2X2 ACOUSTICAL TILE
-  PAINTED GYP. BOARD
-  CONCRETE
-  SECURED GYP. BOARD

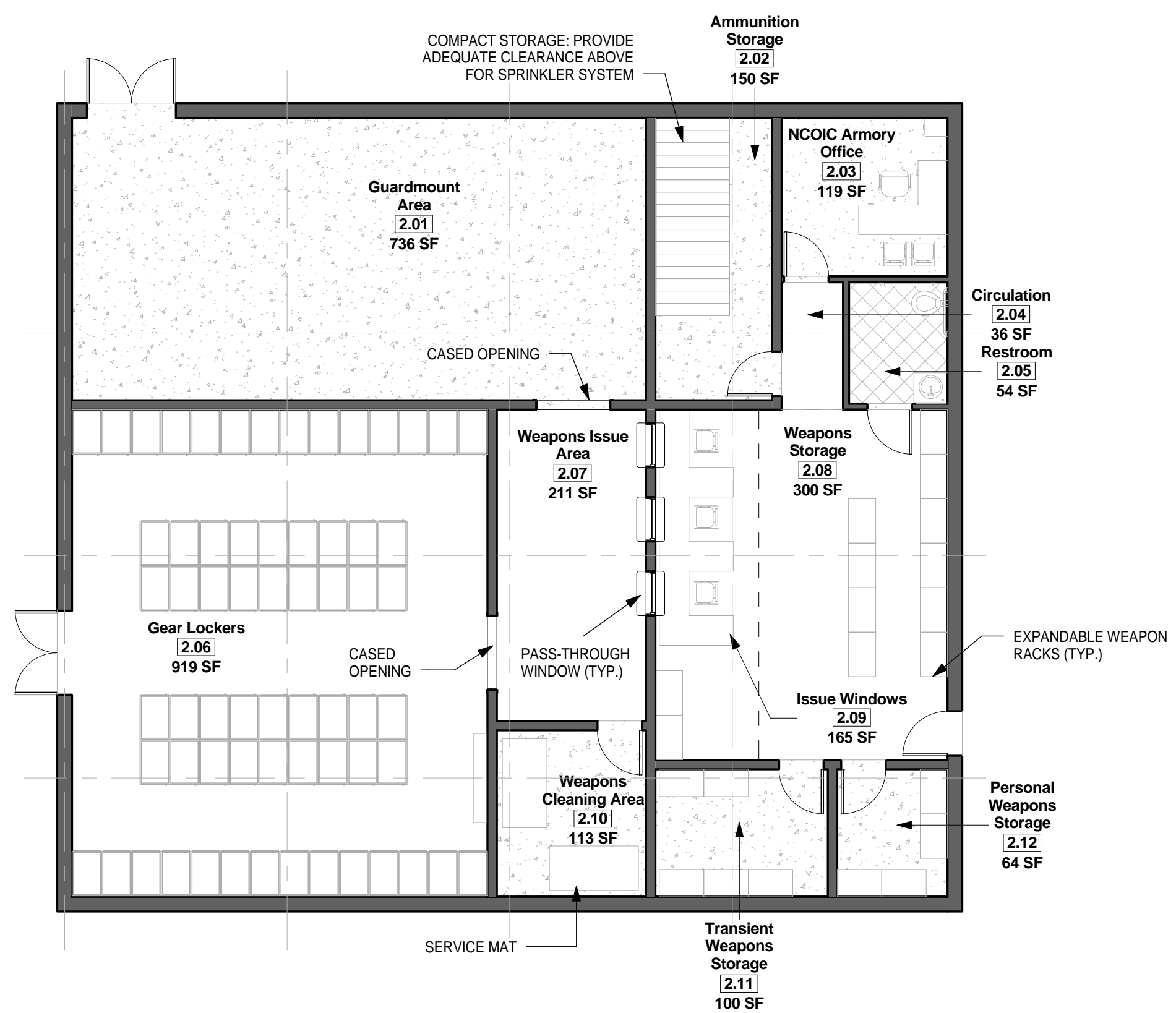

1 Module 2 - Guardmount & Armory - Floor Plan
1/8" = 1'-0"

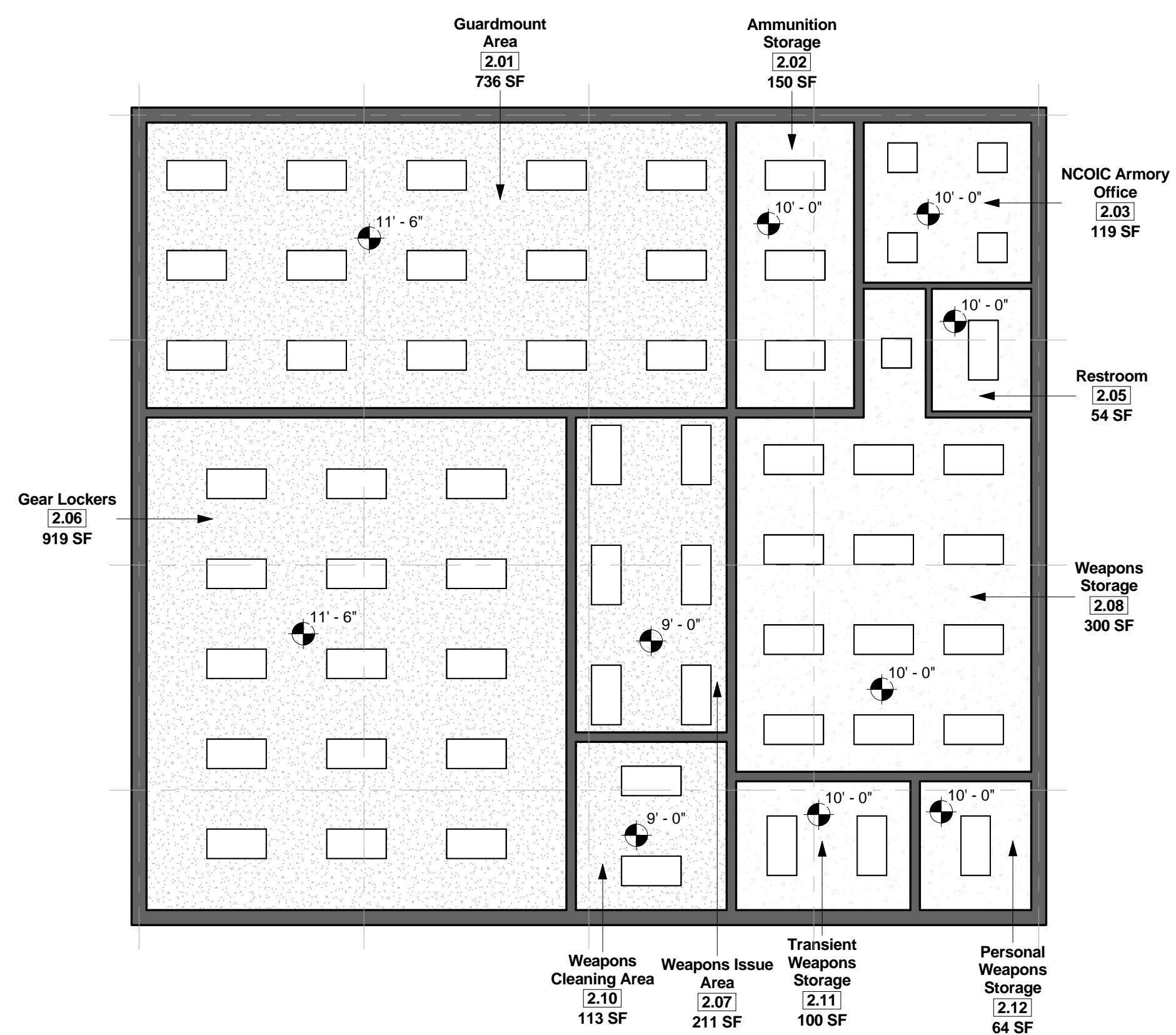

2 Module 2 - Guardmount & Armory - Reflected Ceiling Plan
1/8" = 1'-0"

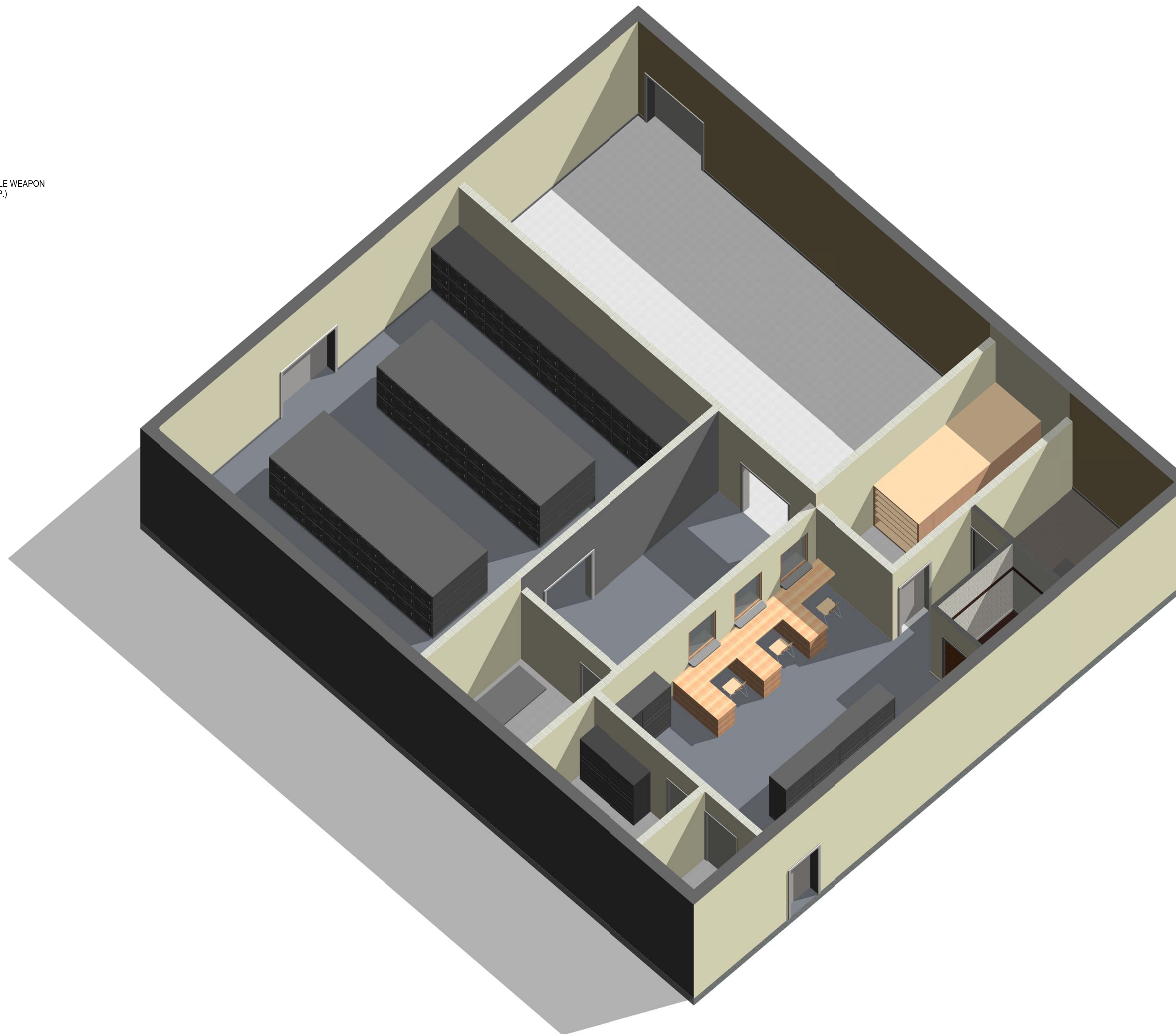

3 Module 2 - Guardmount & Armory

**AIR FORCE CENTER FOR ENGINEERING AND THE ENVIRONMENT (AFCEE)
FACILITIES DYNAMIC PROTOTYPES DESIGN FOR:
SECURITY FORCE OPERATIONS BUILDING
100% DESIGN**

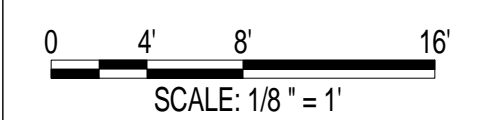

Jacobs Project No.: FDWD0262

Drawing Title:

Guardmount/Armory

Date: 18 NOVEMBER 2011

Designed By: JNM/RB/OF Drawing No.:

Drawn By: JNM/RB/OF

Checked By: JS

A-102





NOT FOR CONSTRUCTION

911 Central Parkway N., Suite 425 San Antonio, TX 78323
501 North Broadway, St. Louis, Missouri 63102-2121





GENERAL NOTES

1. EVERY WALL IS GENERIC UNLESS SPECIFICALLY NOTED
2. EVERY WALL IS A PLACE HOLDER
3. AS THE MODULES ARE COMBINED TO CREATE A FACILITY, DISCRETION SHOULD BE USED AS TO WHICH WALLS NEED TO BE MOVED, ADDED OR REMOVED
4. IF NO WALL IS PRESENT, IT IS THE DESIGN INTENT TO LEAVE THAT SPACE OPEN TO ADJACENT SPACES WITHIN THE FACILITY
5. ALL FURNITURE IS A PLACE HOLDER UNLESS SPECIFICALLY NOTED
6. ALL MODULES HAVE BEEN ORGANIZED BASED ON A 15' GRID.

FLOOR FINISH LEGEND

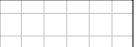
-  CARPET
-  EPOXY PAINT
-  SEALED CONCRETE
-  VCT TILE
-  CERAMIC TILE

CEILING LEGEND

-  2X2 ACOUSTICAL TILE
-  PAINTED GYP. BOARD
-  CONCRETE
-  SECURED GYP. BOARD

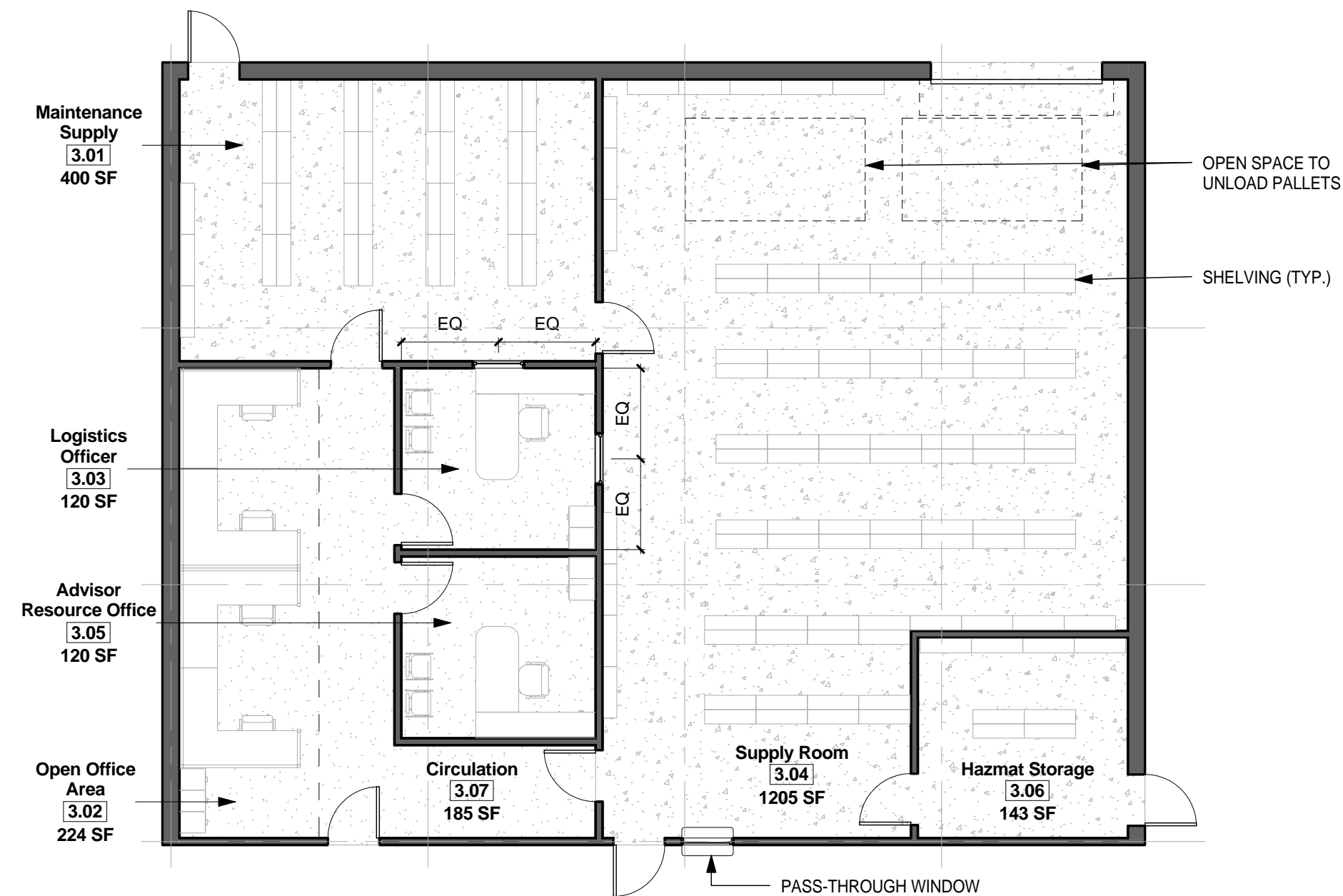

① Module 3 - Mobility and Supply - Floor Plan
1/8" = 1'-0"

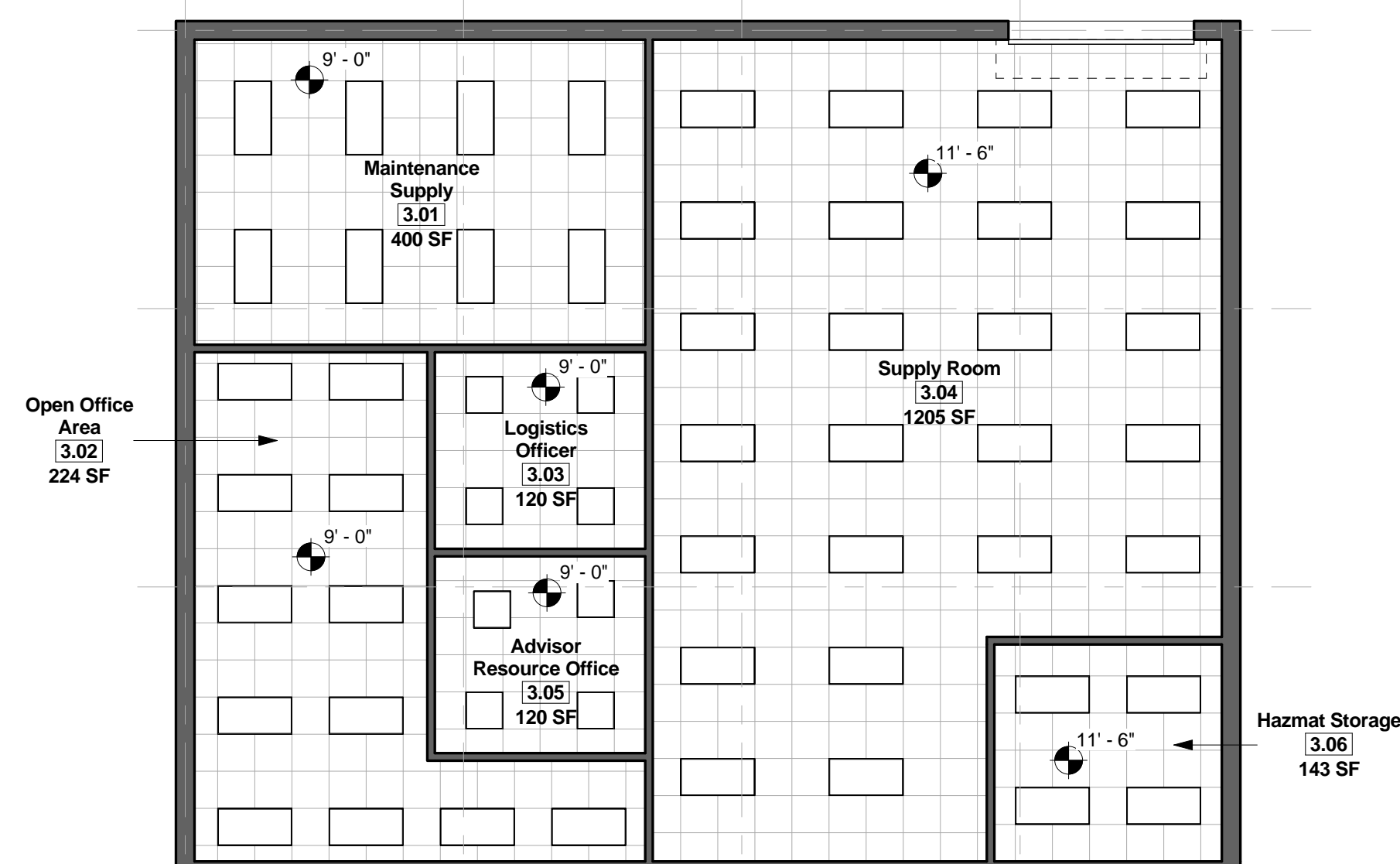

② Module 3 - Mobility and Supply - Reflected Ceiling Plan
1/8" = 1'-0"

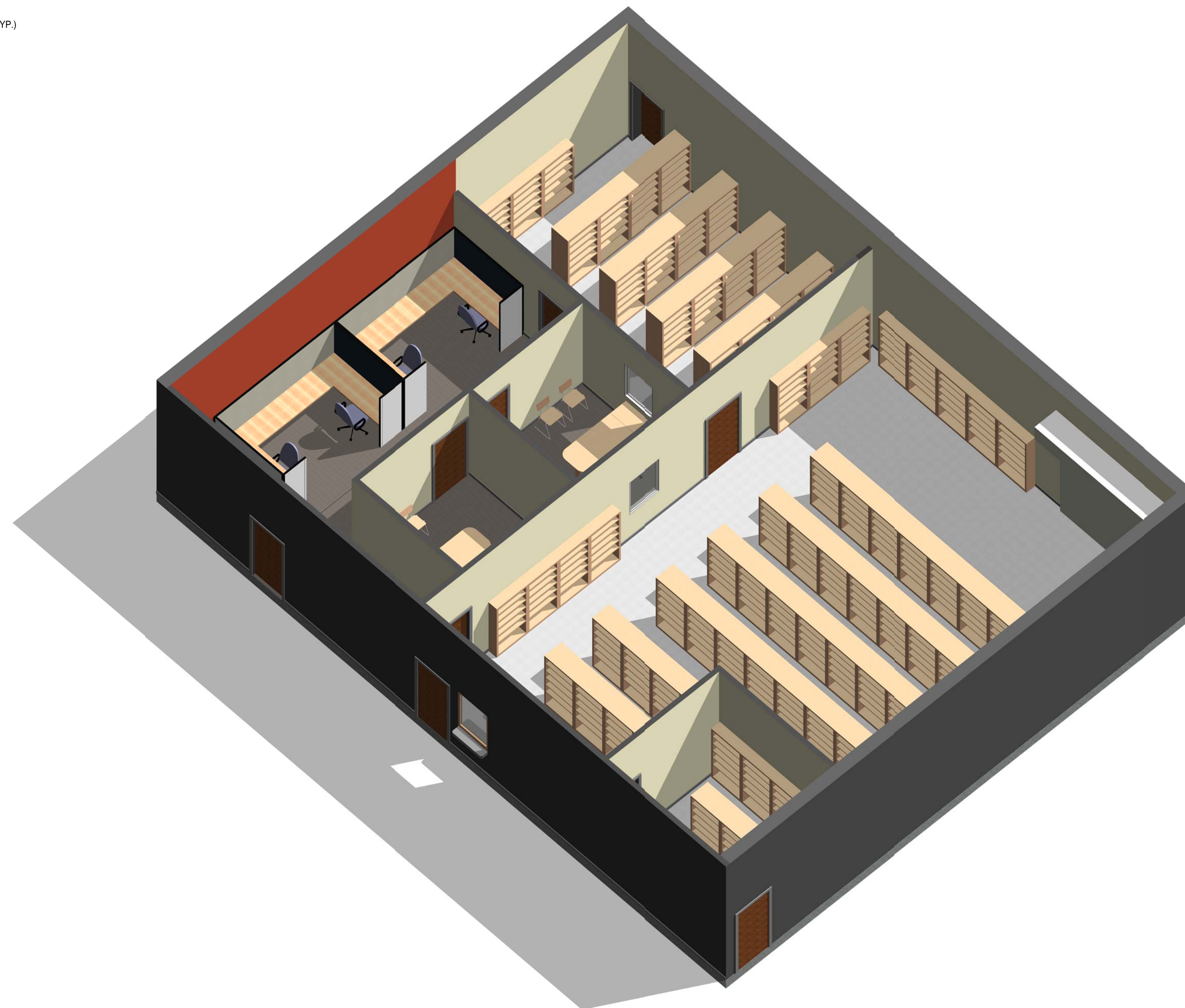

③ Module 3 - Mobility and Supply - Axon

AIR FORCE CENTER FOR ENGINEERING AND THE ENVIRONMENT (AFCEE)
FACILITIES DYNAMIC PROTOTYPES DESIGN FOR:
SECURITY FORCE OPERATIONS BUILDING
100% DESIGN

0 4 8 16'
SCALE: 1/8" = 1'

Jacobs Project No.: FDWD0262

Drawing Title:

Mobility/Supply

Date: 18 NOVEMBER 2011

Designed By: JNMRB/OF Drawing No.:

Drawn By: JNMRB/OF





Checked By: JS

A-103



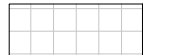

GENERAL NOTES

1. EVERY WALL IS GENERIC UNLESS SPECIFICALLY NOTED
2. EVERY WALL IS A PLACE HOLDER
3. AS THE MODULES ARE COMBINED TO CREATE A FACILITY, DISCRETION SHOULD BE USED AS TO WHICH WALLS NEED TO BE MOVED, ADDED OR REMOVED
4. IF NO WALL IS PRESENT, IT IS THE DESIGN INTENT TO LEAVE THAT SPACE OPEN TO ADJACENT SPACES WITHIN THE FACILITY
5. ALL FURNITURE IS A PLACE HOLDER UNLESS SPECIFICALLY NOTED
6. ALL MODULES HAVE BEEN ORGANIZED BASED ON A 15' GRID.

FLOOR FINISH LEGEND

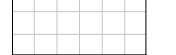
-  CARPET
-  EPOXY PAINT
-  SEALED CONCRETE
-  VCT TILE
-  CERAMIC TILE

CEILING LEGEND

-  2X2 ACOUSTICAL TILE
-  PAINTED GYP. BOARD
-  CONCRETE
-  SECURED GYP. BOARD

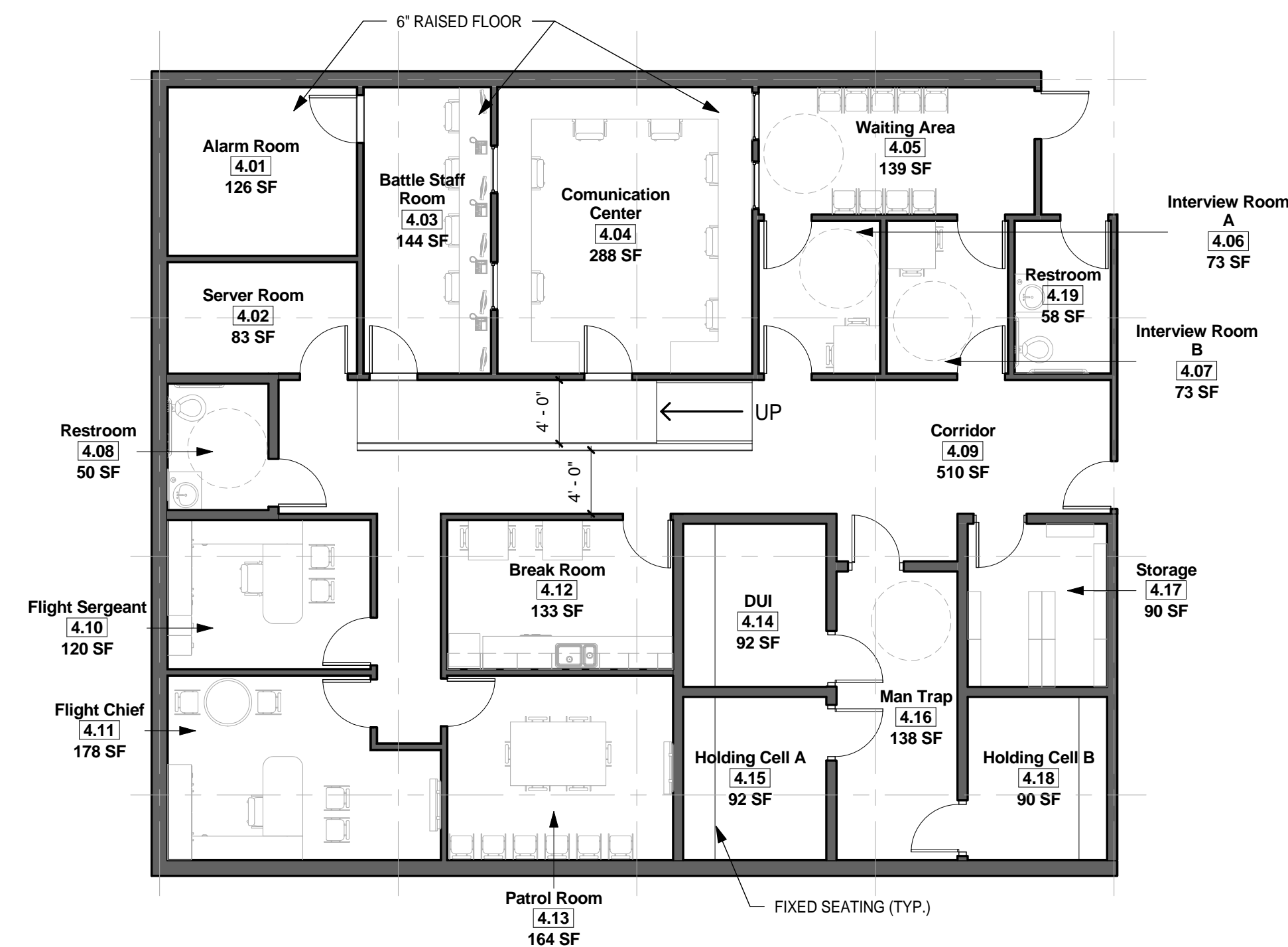

1 Module 4 - ECC/ BDOC - Floor Plan
1/8" = 1'-0"

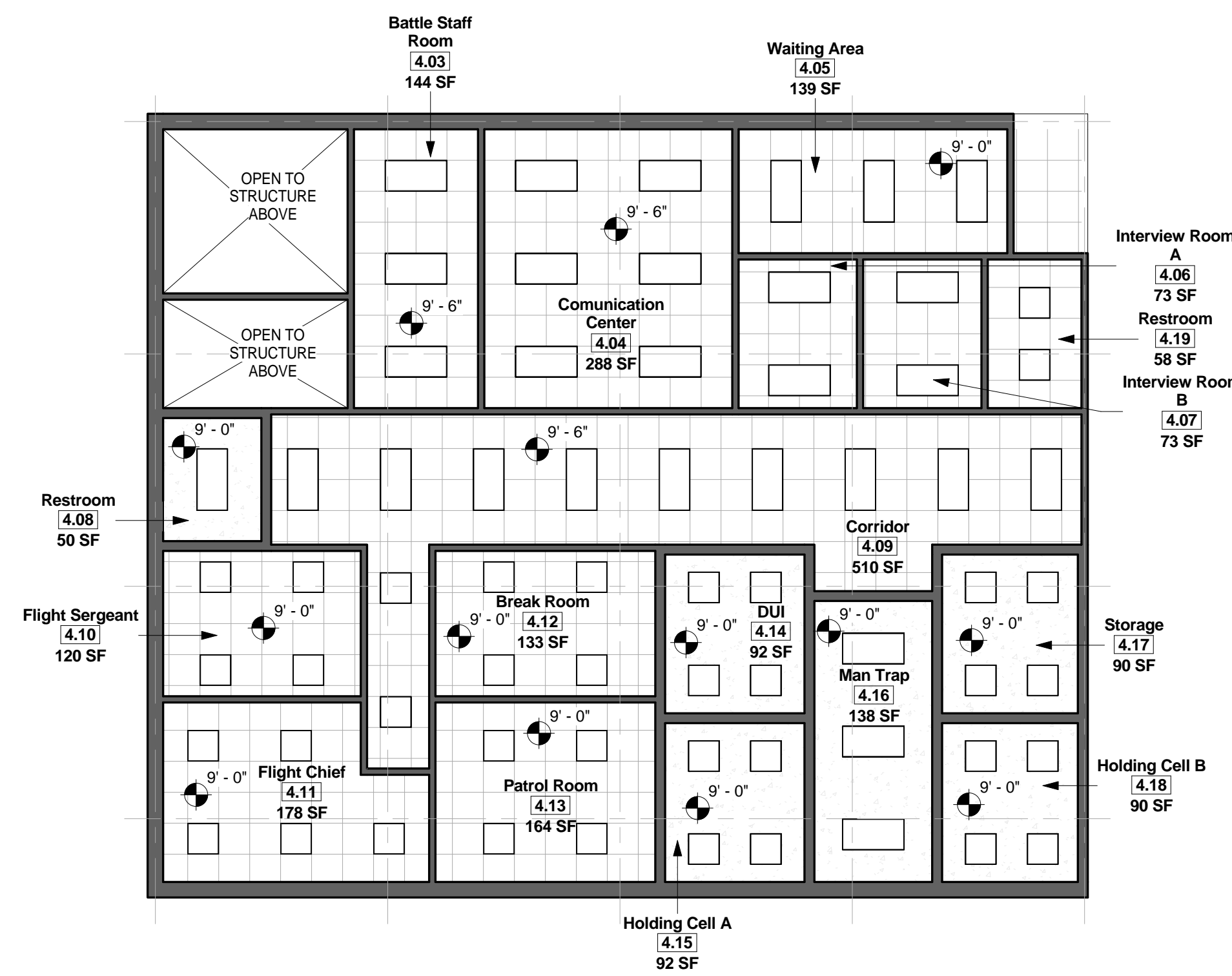

2 Module 4 - ECC/ BDOC - Reflected Ceiling Plan
1/8" = 1'-0"

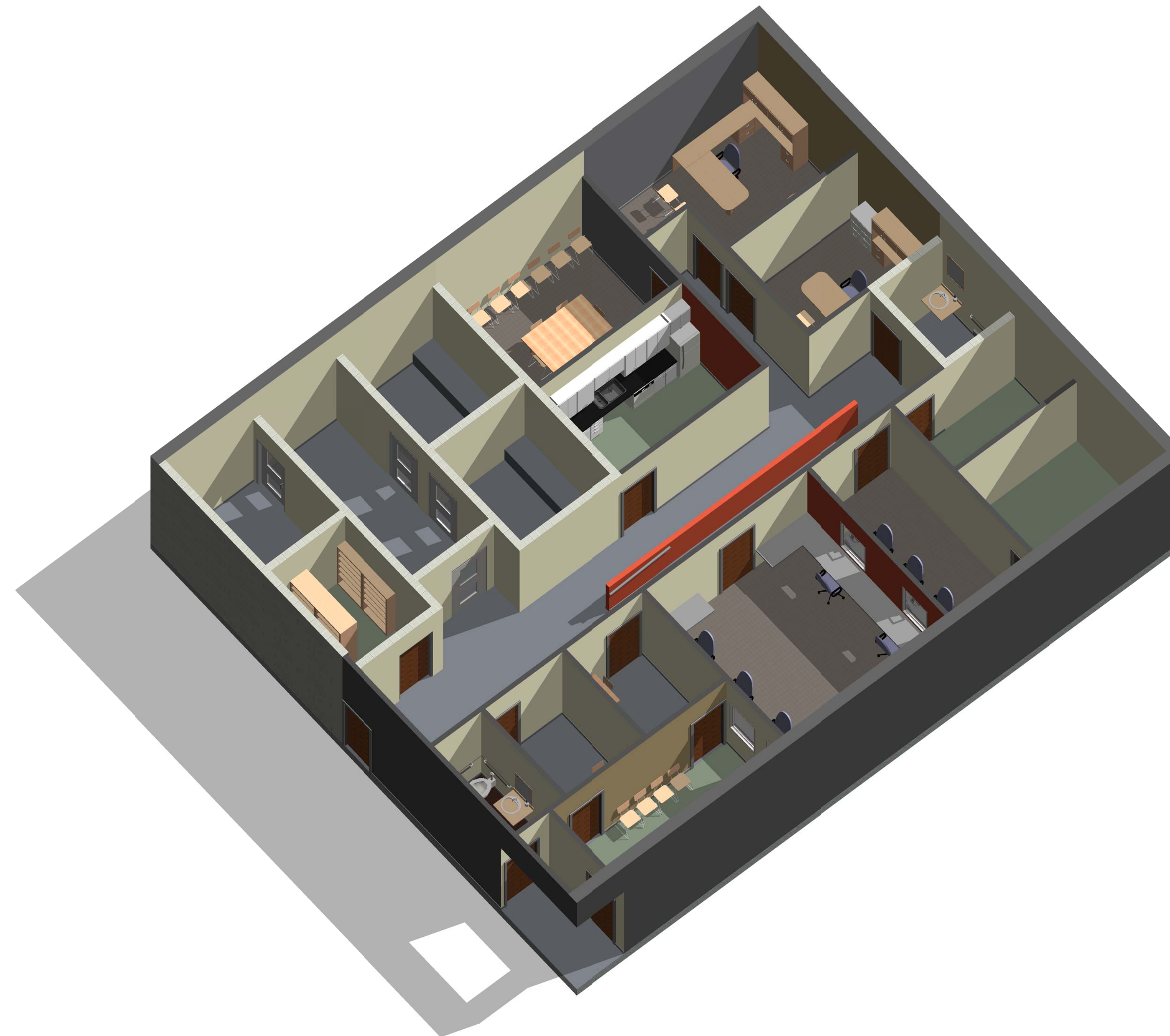

3 Module 4 - ECC/ BDOC - Axon.

AIR FORCE CENTER FOR ENGINEERING AND THE ENVIRONMENT (AFCEE)
FACILITIES DYNAMIC PROTOTYPES DESIGN FOR:
SECURITY FORCE OPERATIONS BUILDING
100% DESIGN

0 4' 8' 16'
SCALE: 1/8" = 1'

Jacobs Project No.: FDWD0262

Drawing Title:

ECC/ BDOC

Date: 18 NOVEMBER 2011

Designed By: JNM/RB/OF Drawing No.:

Drawn By: JNM/RB/OF

Checked By: JS

A-104





NOT FOR CONSTRUCTION

911 Central Parkway N., Suite 425 San Antonio, TX 78323
501 North Broadway, St. Louis, Missouri 63102-2121



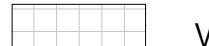

GENERAL NOTES

1. EVERY WALL IS GENERIC UNLESS SPECIFICALLY NOTED
2. EVERY WALL IS A PLACE HOLDER
3. AS THE MODULES ARE COMBINED TO CREATE A FACILITY, DISCRETION SHOULD BE USED AS TO WHICH WALLS NEED TO BE MOVED, ADDED OR REMOVED
4. IF NO WALL IS PRESENT, IT IS THE DESIGN INTENT TO LEAVE THAT SPACE OPEN TO ADJACENT SPACES WITHIN THE FACILITY
5. ALL FURNITURE IS A PLACE HOLDER UNLESS SPECIFICALLY NOTED
6. ALL MODULES HAVE BEEN ORGANIZED BASED ON A 15' GRID.

FLOOR FINISH LEGEND

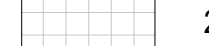
-  CARPET
-  EPOXY PAINT
-  SEALED CONCRETE
-  VCT TILE
-  CERAMIC TILE

CEILING LEGEND

-  2X2 ACOUSTICAL TILE
-  PAINTED GYP. BOARD
-  CONCRETE
-  SECURED GYP. BOARD

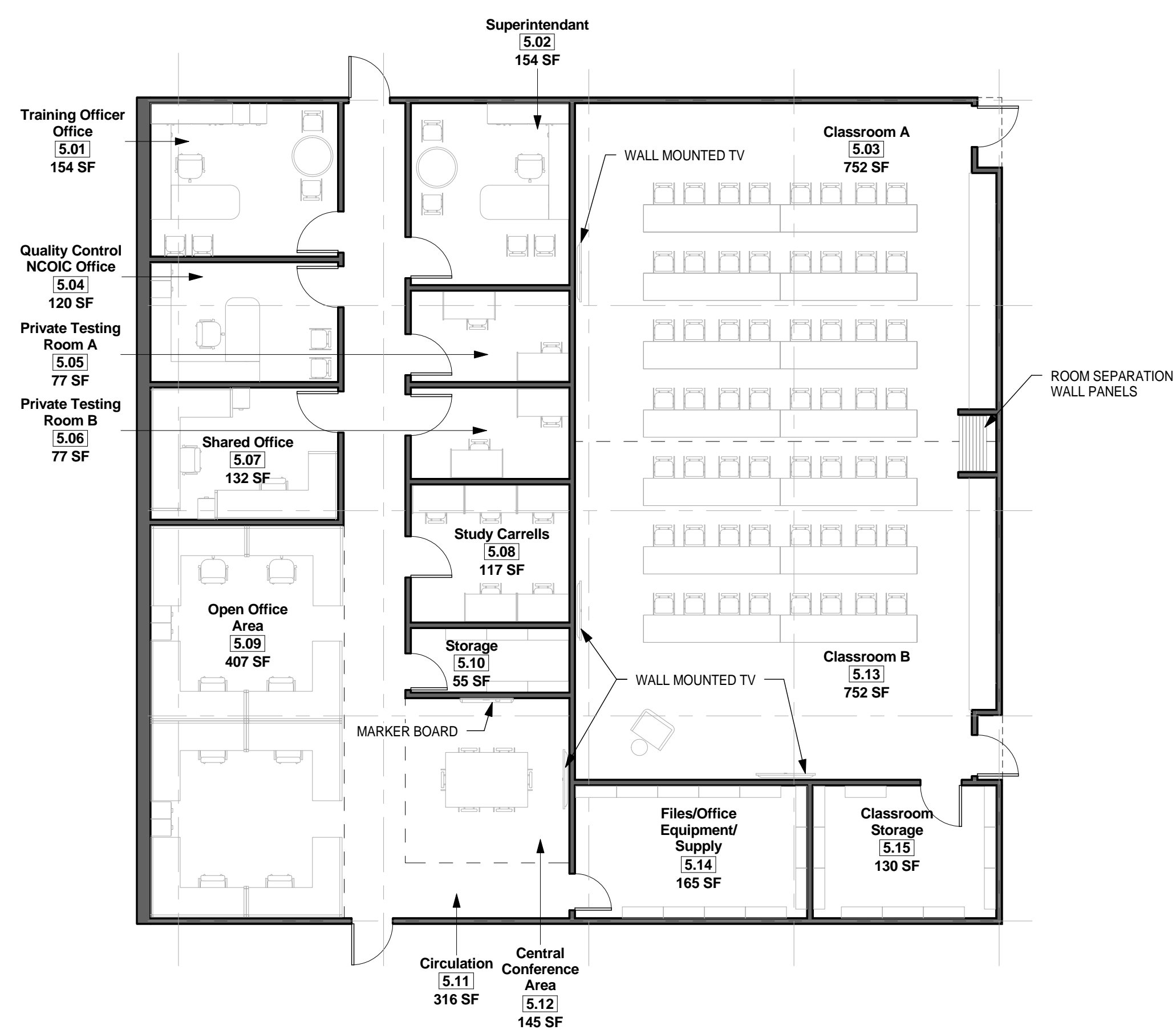

① Module 5 - Training & Quality - Floor Plan
1/8" = 1'-0"

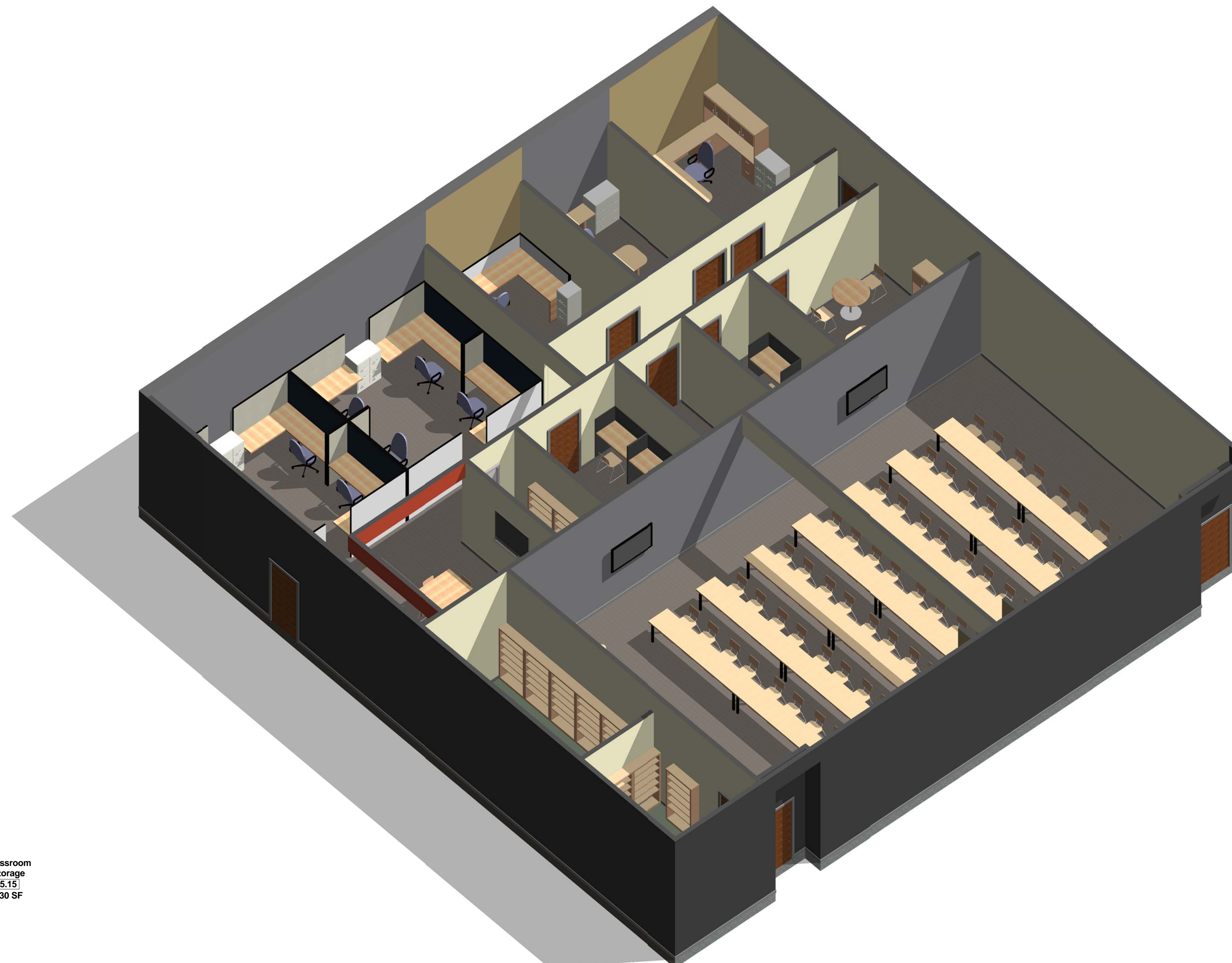

③ Module 5 - Training & Quality Axon.

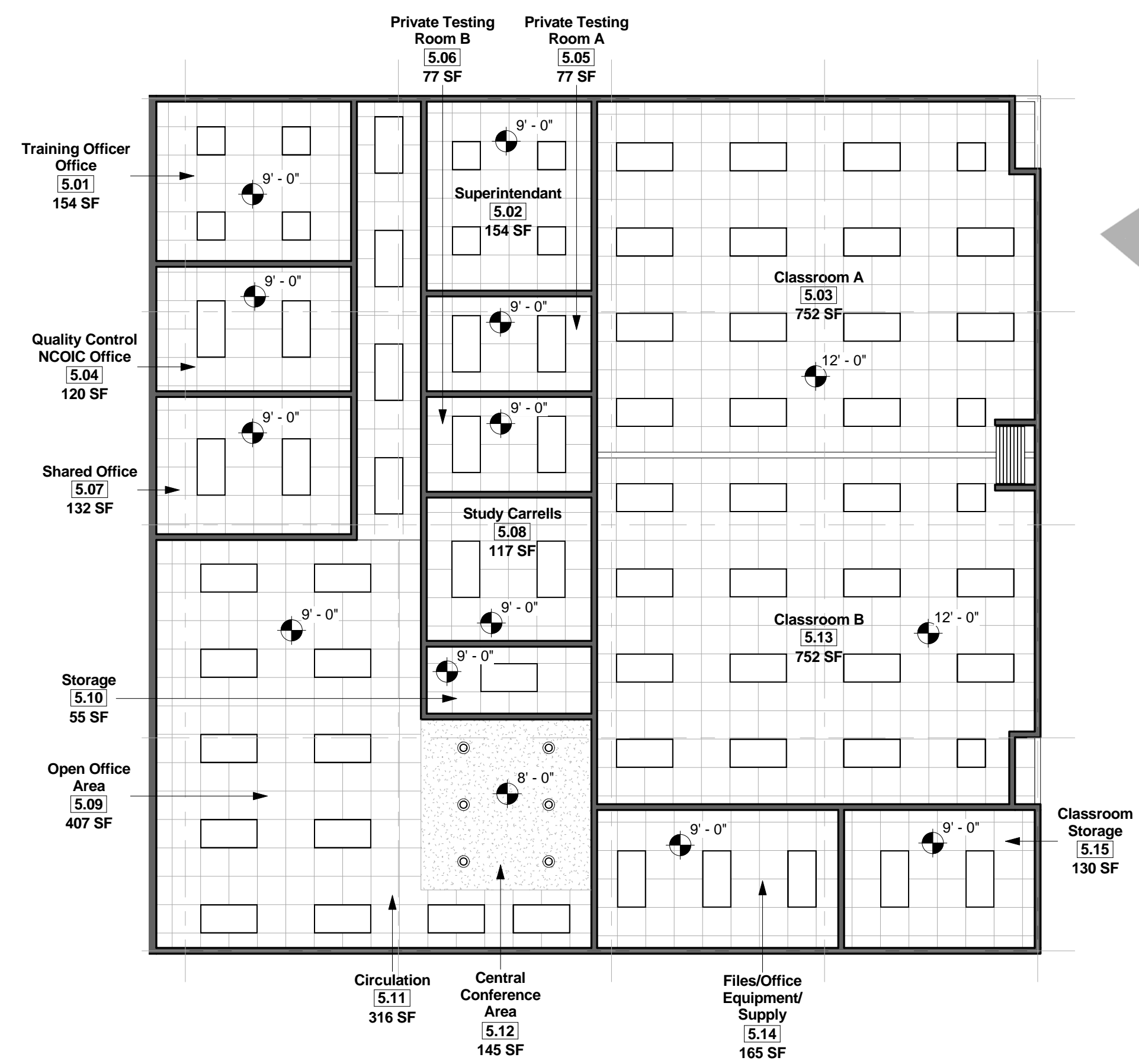

② Module 5 - Training & Quality - Reflected Ceiling Plan
1/8" = 1'-0"

AIR FORCE CENTER FOR ENGINEERING AND THE ENVIRONMENT (AFCEE)
FACILITIES DYNAMIC PROTOTYPES DESIGN FOR:
SECURITY FORCE OPERATIONS BUILDING
100% DESIGN

0 4' 8' 16'
SCALE: 1/8" = 1'

Jacobs Project No.: FDWD0262

Drawing Title:

Training/Quality

Date: 18 NOVEMBER 2011

Designed By: JNM/RB/OF Drawing No.:

Drawn By: JNM/RB/OF

Checked By: JS

A-105

NOT FOR CONSTRUCTION

911 Central Parkway N., Suite 425 San Antonio, TX 78323
501 North Broadway, St. Louis, Missouri 63102-2121

AIR FORCE CENTER FOR ENGINEERING AND THE ENVIRONMENT (AFCEE)
 FACILITIES DYNAMIC PROTOTYPES DESIGN FOR:
SECURITY FORCE OPERATIONS BUILDING
 100% DESIGN

D
C
B
A

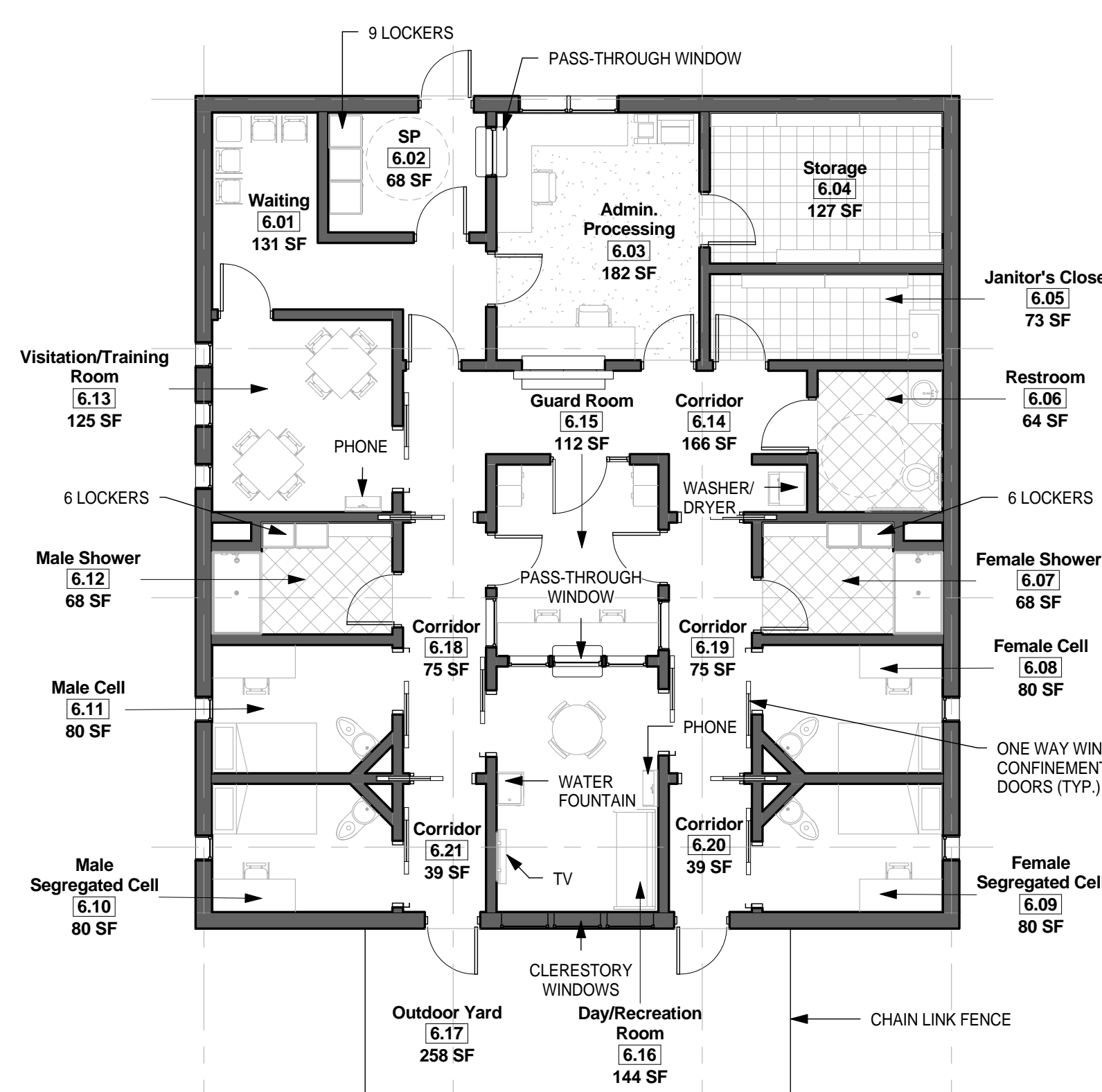

1 Module 6 - Confinement - Floor Plan
1/8" = 1'-0"

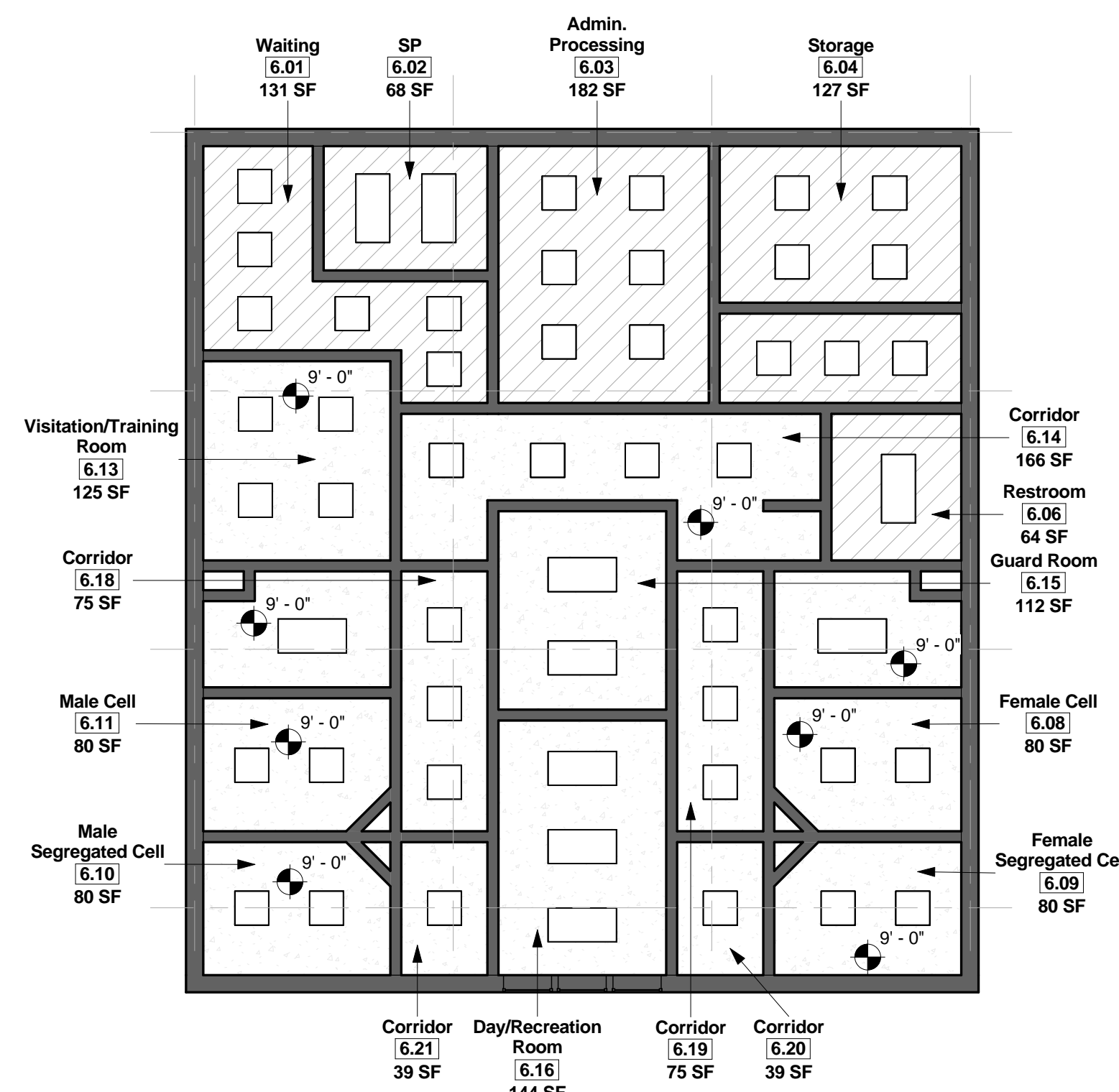

2 Module 6 - Confinement - Reflected Ceiling Plan
1/8" = 1'-0"

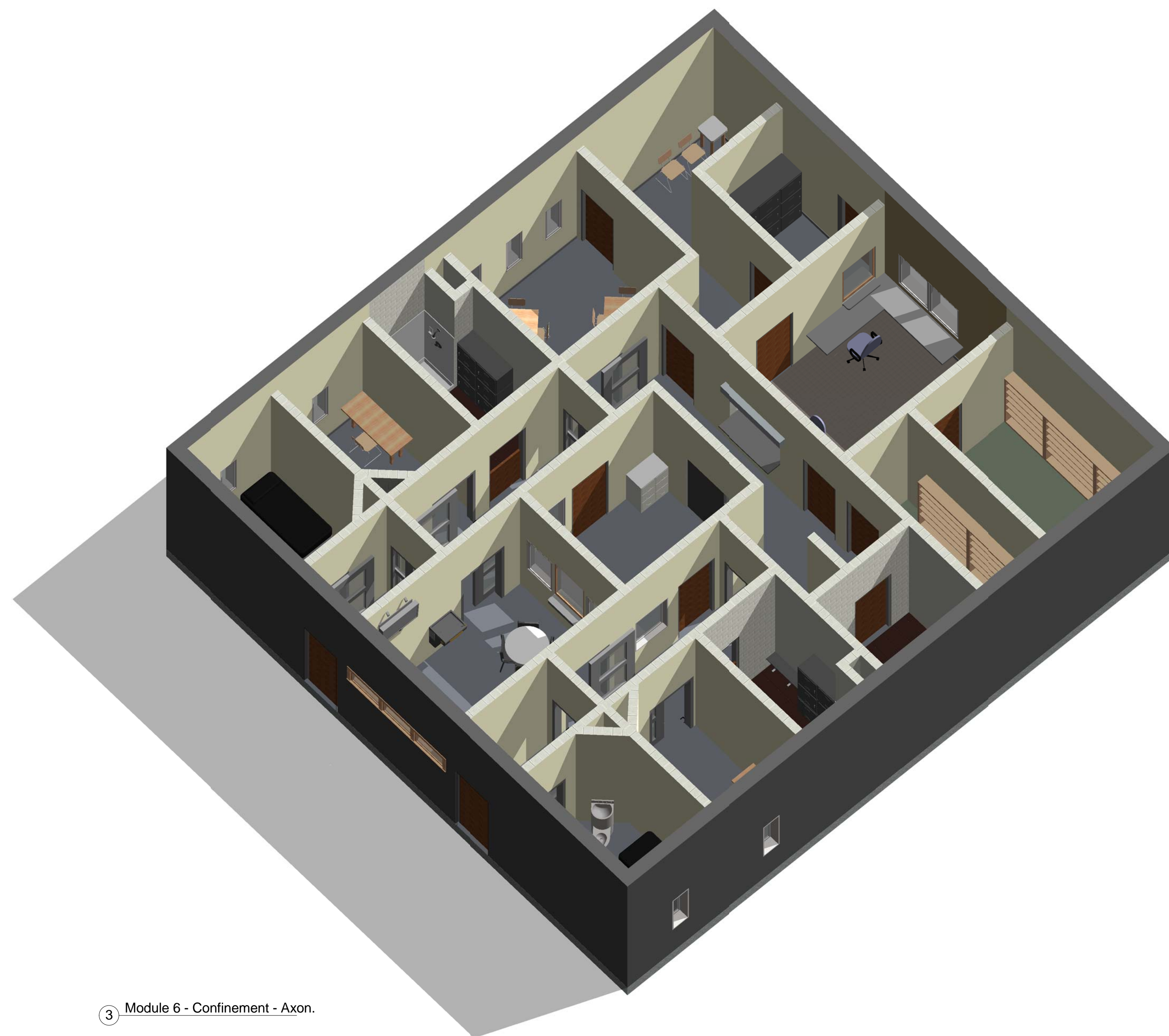

3 Module 6 - Confinement - Axon.

GENERAL NOTES

- EVERY WALL IS GENERIC UNLESS SPECIFICALLY NOTED
- EVERY WALL IS A PLACE HOLDER
- AS THE MODULES ARE COMBINED TO CREATE A FACILITY, DISCRETION SHOULD BE USED AS TO WHICH WALLS NEED TO BE MOVED, ADDED OR REMOVED
- IF NO WALL IS PRESENT, IT IS THE DESIGN INTENT TO LEAVE THAT SPACE OPEN TO ADJACENT SPACES WITHIN THE FACILITY
- ALL FURNITURE IS A PLACE HOLDER UNLESS SPECIFICALLY NOTED
- ALL MODULES HAVE BEEN ORGANIZED BASED ON A 15' GRID.

FLOOR FINISH LEGEND

- CARPET
- EPOXY PAINT
- SEALED CONCRETE
- VCT TILE
- CERAMIC TILE

CEILING LEGEND

- 2X2 ACOUSTICAL TILE
- PAINTED GYP. BOARD
- CONCRETE
- SECURED GYP. BOARD

CONFINEMENT MODULE NOTES

- USE CORRECTIONAL LIGHTING (TAMPER PROOF LENSES/BALLASTS).
 - PROVIDE AN EXTERIOR LOCKED "KNOX BOX" IF BUILT AS A STAND ALONE FACILITY.
 - FIRE ESCAPE ELECTRONIC RELEASE DOORS TO OUTDOOR RECREATIONAL YARD WILL BE CONNECTED TO ECC/ BDOC'S BACKUP GENERATOR.
 - USE SECURITY HARDWARE (SCREWS/BOLTS) THROUGHOUT.
- ADMIN/ PROCESSING**
- PROVIDE ACCESS CONTROL PANEL TO CONTROL SALLY PORT AND OUTDOOR RECREATIONAL YARD EXIT DOORS.
 - PROVIDE REDUNDANT DISPLAY APPLICABILITY (RDA) TO CONTROL SALLY PORT DOORS FROM ADMIN. & GUARD ROOM.
 - PROVIDE LOCKABLE, WALL-MOUNTED KEY BOX & SMALL LOCKABLE SECURITY DRAWER/SAFE.
 - USE ONE WAY GLASS ON WINDOWS TO PREVENT CONFINEE'S VISITORS' VIEW TO STAFF.
 - OPTIONAL. USE ACOUSTICAL TILES IN CEILING.

- GUARD ROOM**
- PROVIDE LOCKABLE, WALL-MOUNTED KEY BOX & LOCKABLE MEDICINE STORAGE BOX.
 - PROVIDE AN ON/OFF SWITCH FOR THE PHONE IN THE VISITATION/ TRAINING ROOM.
 - USE ONE WAY GLASS TO PREVENT CONFINEE'S VIEW TO STAFF.
 - OPTIONAL. USE ACOUSTICAL TILES IN CEILING.

- DAY/ RECREATION ROOM**
- IN COLD-WEATHER CLIMATES, PROVIDE EXTRA SPACE FOR EXERCISE EQUIPMENT.
 - DOORS SHOULD NOT SWING IN.

- CONFINEMENT CELLS**
- PROVIDE AN ON/OFF SWITCH OUTSIDE OF THE CELL TO CONTROL THE ELECTRICAL OUTLET WITHIN THE CELL.
 - PROVIDE A METAL DEMOUNTABLE BED (WALL AND/OR FLOOR MOUNTED), DESK, SHELF, AND BREAKAWAY CLOTHES HOOK IN EACH CELL.
 - USE SECURITY ONE-PIECE SAFETY MIRRORS.
 - USE ALL IN ONE TOILET, BUBBLER, AND SINK.
 - USE EMERGENCY LIGHTING (BACKUP POWERED) AND TAMPER-PROOF (DETENTION) LIGHTING.
 - CELL DOORS SHOULD NOT HAVE ONE WAY GLASS AND CAN EITHER SLIDE OR OPEN OUT.
 - DO NOT USE BASEBOARDS.

- CORRIDORS**
- BETWEEN THE MALE AND FEMALE CELLS, USE SLIDING, POCKET, OR BIFOLD DOORS. THE PRIMARY FUNCTION OF THIS DOOR IS FOR SOUND ABATEMENT.

- SHOWERS**
- USE BREAKAWAY CLOTHES HOOKS.

- SALLY PORT**
- ENSURE SALLY PORT IS LONG AND WIDE ENOUGH FOR AN EMS STRETCHER/GURNEY TO PASS THROUGH.

- DOORS**
- INSTITUTION SHOWER DOORS ARE CENTERED HALF-DOORS (TOP AND BOTTOM OPEN).
 - USE SOLID MINIMUM INSTITUTION RATED DOORS THROUGHOUT. CELL AND CORRIDOR DOORS SHOULD BE MAXIMUM SECURITY RATED.

- WALL CONSTRUCTION**
- THE ENTIRE CONFINEMENT AREA FOOTPRINT NEEDS TO BE SOLID SECURITY RATED TO LEVEL 1 CONFINEMENT WALLS. THE WALLS SHOULD BE 8-INCH THICK CONCRETE MASONRY UNITS WITH CELLS FILLED FULL HEIGHT WITH GROUT CONFORMING TO ASTM C476; VERTICAL REINFORCEMENT NOT REQUIRED FOR SECURITY; EXTEND WALL TO UNDERSIDE OF STRUCTURE. CRITERIA DOES NOT PRECLUDE THE USE OF OTHER MATERIALS MORE READILY AVAILABLE IN THE LOCAL MARKET PROVIDED THEY MEET OR EXCEED THE BASIC REQUIREMENTS.

- CEILING CONSTRUCTION**
- THE CELL CEILING SYSTEM SHALL BE CAST-IN-PLACE CONCRETE WITH A MINIMUM THICKNESS OF 5 INCHES OF REINFORCED CONCRETE WITH 6X6 - W1.4 X W1.4 WELDED WIRE FABRIC. SLAB AREA EXPOSED TO THE CELL SHALL HAVE A STEEL TROWEL FINISH. THE ENTIRE CONFINEMENT AREA CAN BE MADE THIS WAY OR THE CIRCUMFERENCE OF THE AREA WOULD NEED TO HAVE 14 GAUGE STEEL PLATE FROM FLOOR TO DECK (TO PREVENT CONFINEE'S ACCESS TO THE ENTIRE SECURITY FORCES COMPLEX CEILING AND ESCAPE VIA A DIFFERENT ROOM IN THE BUILDING).



Jacobs Project No.: FDWD0262

Drawing Title:

Confinement

Date: 18 NOVEMBER 2011

Designed By: JNMRB/OF Drawing No.:

Drawn By: JNMRB/OF

Checked By: js

A-106





**NOT FOR
CONSTRUCTION**

911 Central Parkway N., Suite 425 San Antonio, TX 78233
501 North Broadway, St. Louis, Missouri 63102-2121



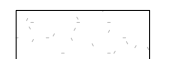

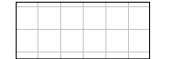
GENERAL NOTES

1. EVERY WALL IS GENERIC UNLESS SPECIFICALLY NOTED
2. EVERY WALL IS A PLACE HOLDER
3. AS THE MODULES ARE COMBINED TO CREATE A FACILITY, DISCRETION SHOULD BE USED AS TO WHICH WALLS NEED TO BE MOVED, ADDED OR REMOVED
4. IF NO WALL IS PRESENT, IT IS THE DESIGN INTENT TO LEAVE THAT SPACE OPEN TO ADJACENT SPACES WITHIN THE FACILITY
5. ALL FURNITURE IS A PLACE HOLDER UNLESS SPECIFICALLY NOTED
6. ALL MODULES HAVE BEEN ORGANIZED BASED ON A 15' GRID.

FLOOR FINISH LEGEND

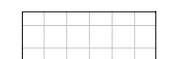
-  CARPET
-  EPOXY PAINT
-  SEALED CONCRETE
-  VCT TILE
-  CERAMIC TILE

CEILING LEGEND

-  2X2 ACOUSTICAL TILE
-  PAINTED GYP. BOARD
-  CONCRETE
-  SECURED GYP. BOARD

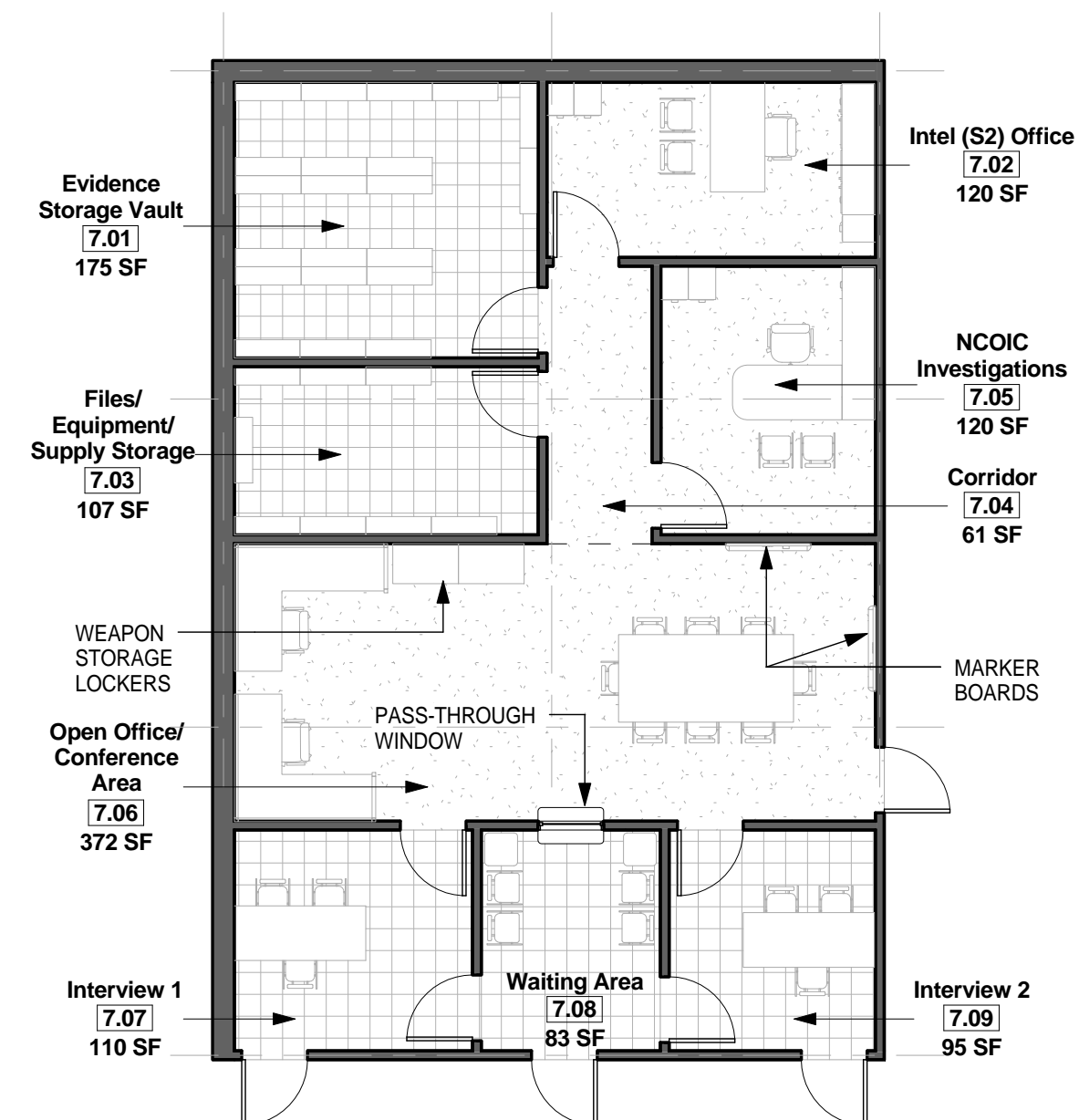

② Module 7 - Investigation/ S2 - Floor Plan
1/8" = 1'-0"

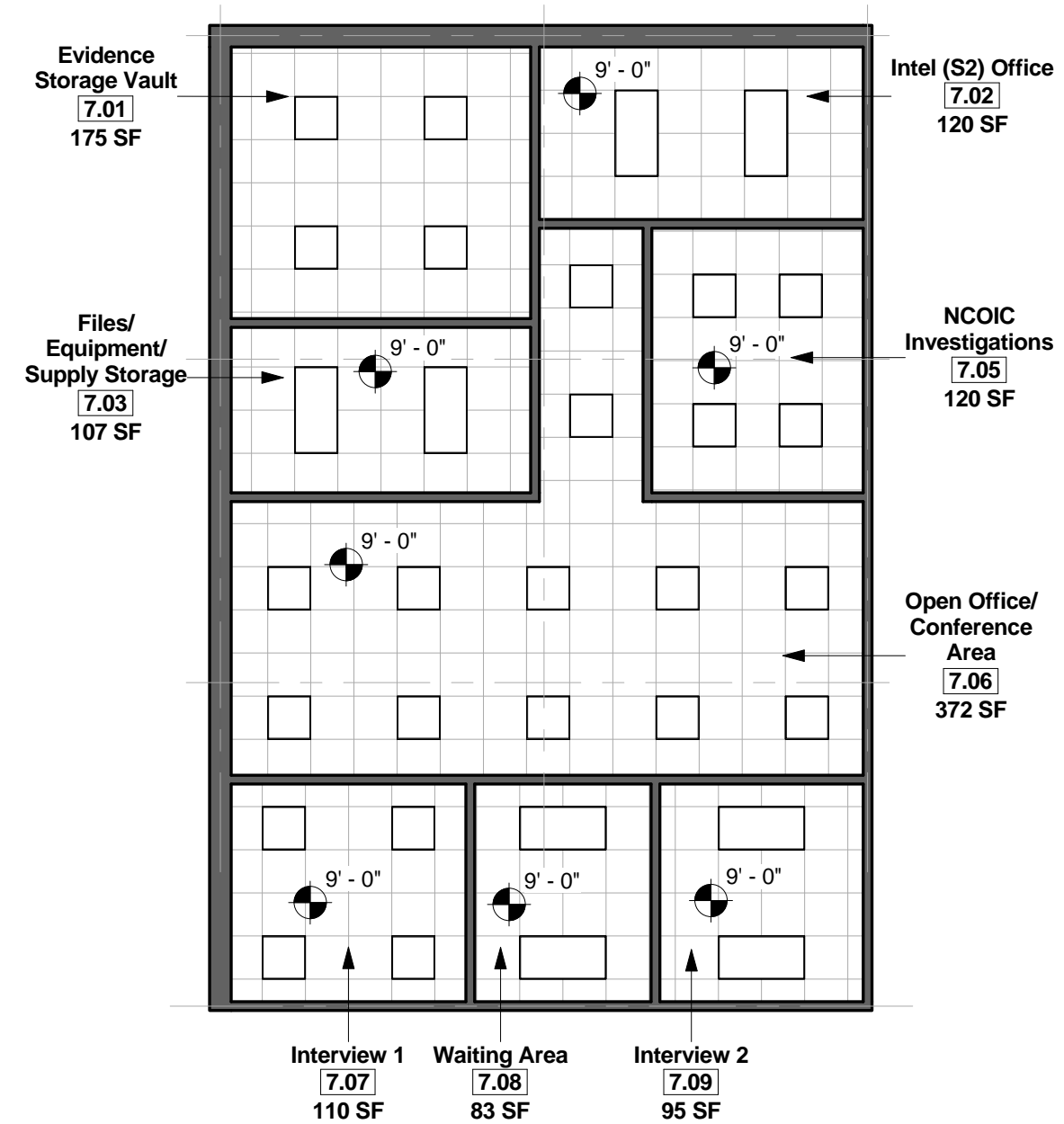

③ Module 7 - Investigation/ S2 - Reflected Ceiling Plan
1/8" = 1'-0"



① Module 7 - Investigation/ S2 - Axon.

**AIR FORCE CENTER FOR ENGINEERING AND
THE ENVIRONMENT (AFCEE)
FACILITIES DYNAMIC PROTOTYPES DESIGN FOR:
SECURITY FORCE OPERATIONS BUILDING
100% DESIGN**

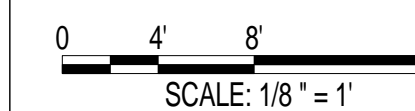

Jacobs Project No.: FDWD0262

Drawing Title:

Investigation/ S2

Date: 18 NOVEMBER 2011

Designed By: JNM/RB/OF Drawing No.:

Drawn By: JNM/RB/OF

Checked By: JS **A-107**





NOT FOR
CONSTRUCTION

911 Central Parkway N., Suite 425 San Antonio, TX 78323
501 North Broadway, St. Louis, Missouri 63102-2121



GENERAL NOTES

1. EVERY WALL IS GENERIC UNLESS SPECIFICALLY NOTED
2. EVERY WALL IS A PLACE HOLDER
3. AS THE MODULES ARE COMBINED TO CREATE A FACILITY, DISCRETION SHOULD BE USED AS TO WHICH WALLS NEED TO BE MOVED, ADDED OR REMOVED
4. IF NO WALL IS PRESENT, IT IS THE DESIGN INTENT TO LEAVE THAT SPACE OPEN TO ADJACENT SPACES WITHIN THE FACILITY
5. ALL FURNITURE IS A PLACE HOLDER UNLESS SPECIFICALLY NOTED
6. ALL MODULES HAVE BEEN ORGANIZED BASED ON A 15' GRID.

FLOOR FINISH LEGEND

-  CARPET
-  EPOXY PAINT
-  SEALED CONCRETE
-  VCT TILE
-  CERAMIC TILE

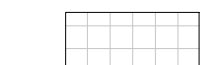
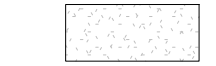
CEILING LEGEND

-  2X2 ACOUSTICAL TILE
-  PAINTED GYP. BOARD
-  CONCRETE
-  SECURED GYP. BOARD

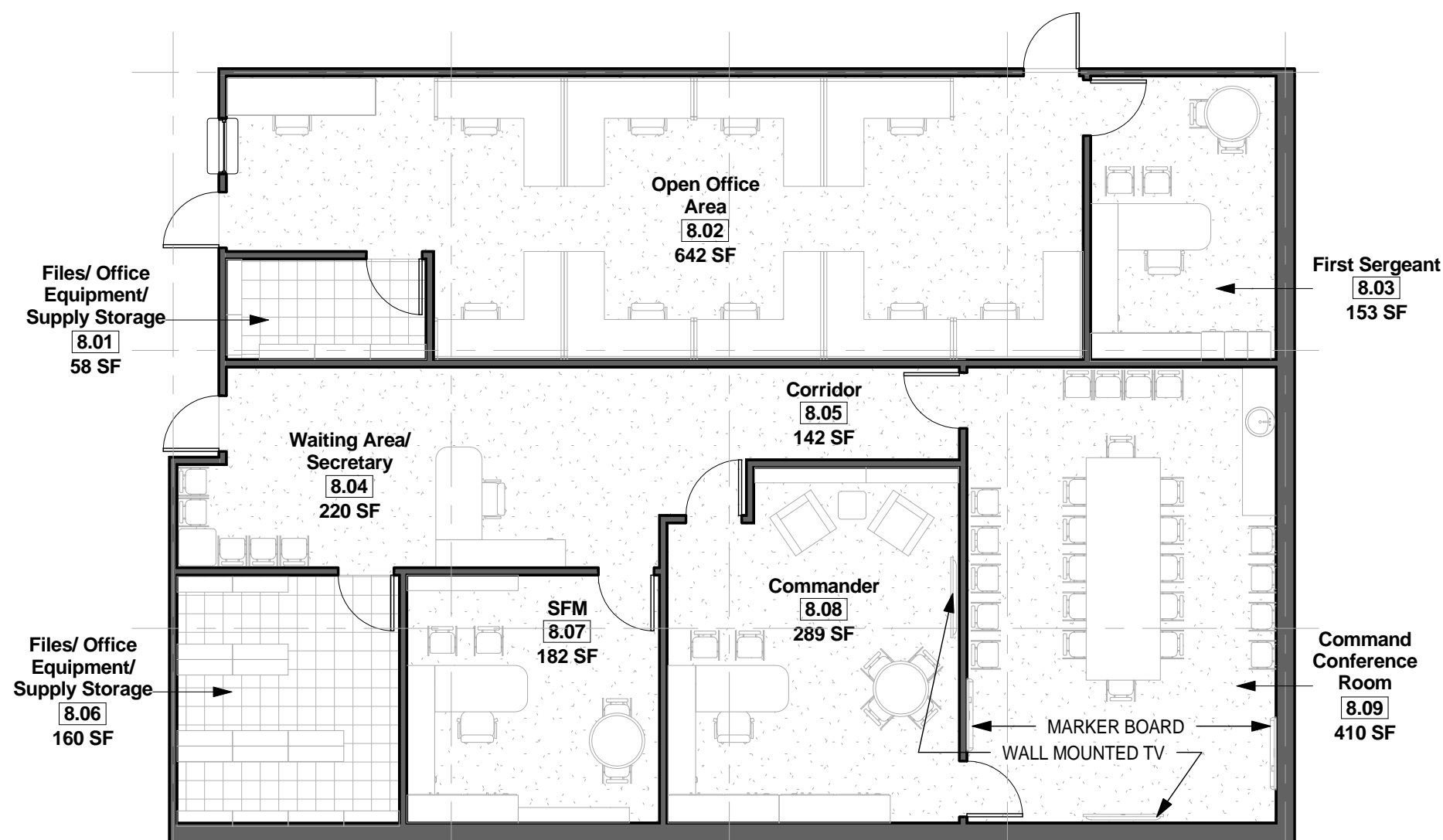

① Module - 8 Command and Orderly
1/8" = 1'-0"

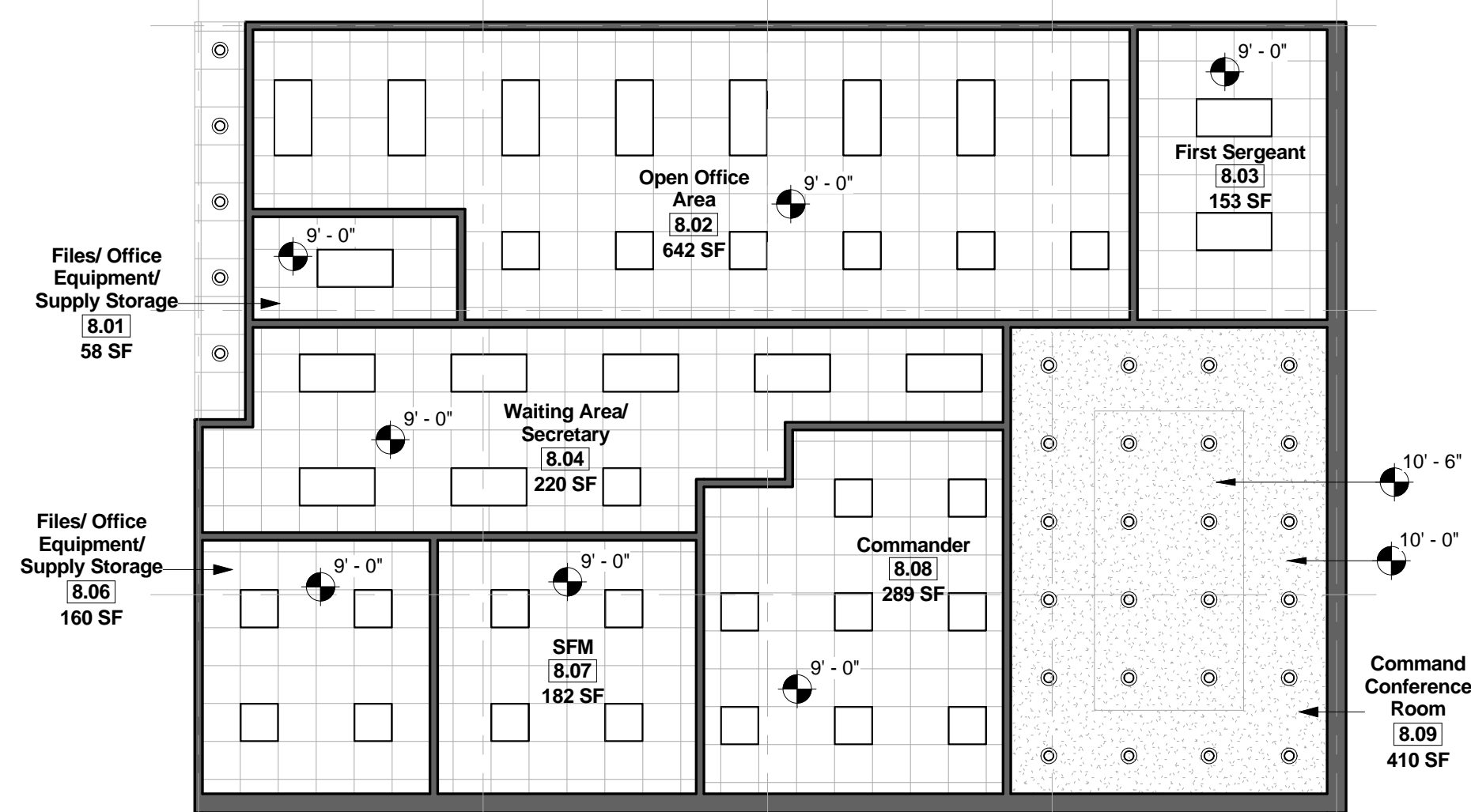

② Module 8- Command and Orderly - Reflected Ceiling Plan
1/8" = 1'-0"

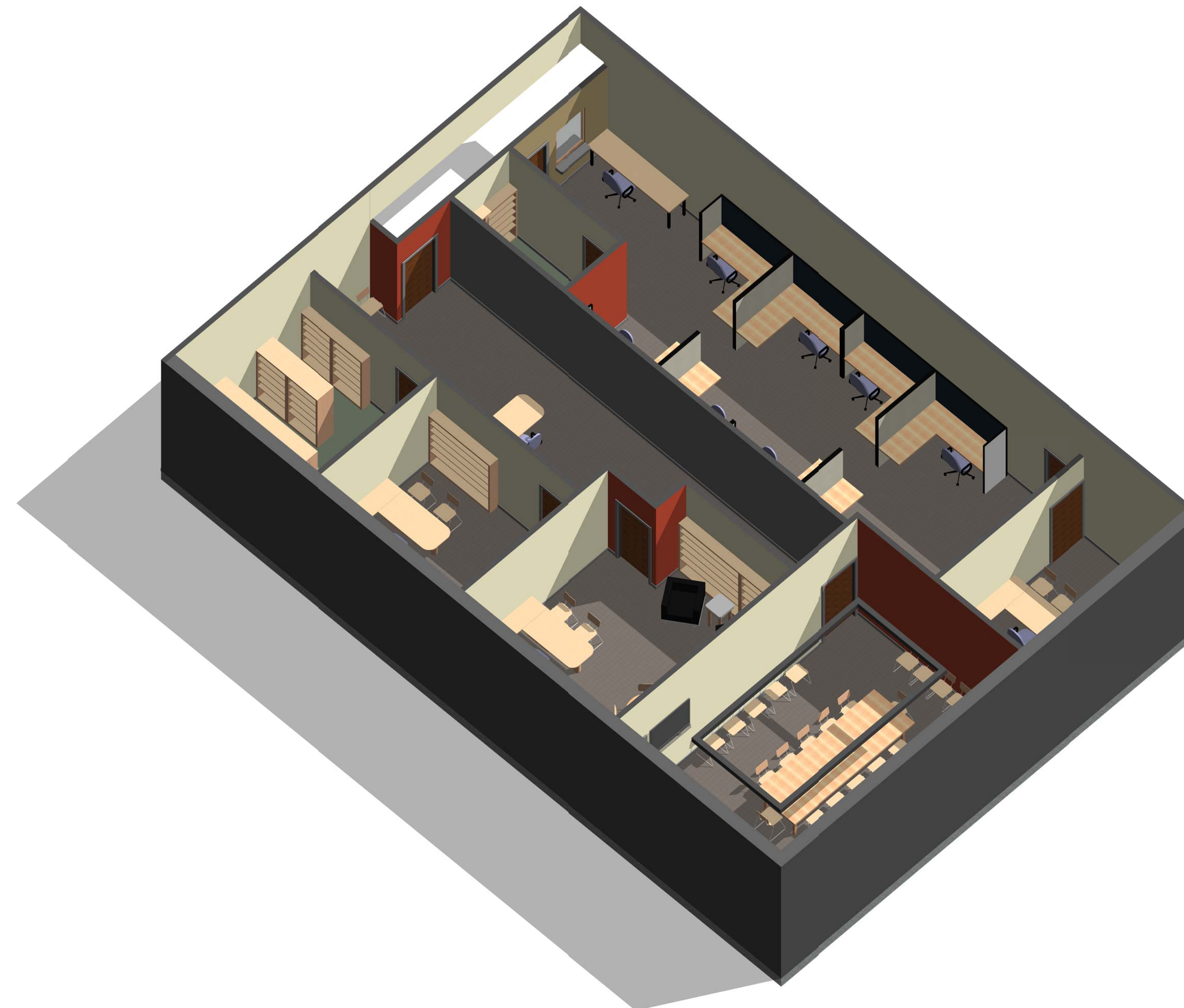

③ Module 8 - Command and Orderly

AIR FORCE CENTER FOR ENGINEERING AND
THE ENVIRONMENT (AFCEE)
FACILITIES DYNAMIC PROTOTYPES DESIGN FOR:
SECURITY FORCE OPERATIONS BUILDING
100% DESIGN

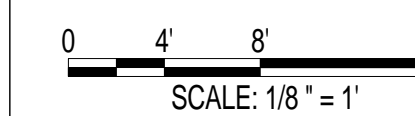

Jacobs Project No.: FDWD0262

Drawing Title:

Command/ Orderly

Date: 18 NOVEMBER 2011

Designed By: JNM/RB/OF Drawing No.:

Drawn By: JNM/RB/OF

Checked By: JS

A-108

GENERAL NOTES

1. EVERY WALL IS GENERIC UNLESS SPECIFICALLY NOTED
2. EVERY WALL IS A PLACE HOLDER
3. AS THE MODULES ARE COMBINED TO CREATE A FACILITY, DISCRETION SHOULD BE USED AS TO WHICH WALLS NEED TO BE MOVED, ADDED OR REMOVED
4. IF NO WALL IS PRESENT, IT IS THE DESIGN INTENT TO LEAVE THAT SPACE OPEN TO ADJACENT SPACES WITHIN THE FACILITY
5. ALL FURNITURE IS A PLACE HOLDER UNLESS SPECIFICALLY NOTED
6. ALL MODULES HAVE BEEN ORGANIZED BASED ON A 15' GRID.

FLOOR FINISH LEGEND

	CARPET
	EPOXY PAINT
	SEALED CONCRETE
	VCT TILE
	CERAMIC TILE

CEILING LEGEND

	2X2 ACOUSTICAL TILE
	PAINTED GYP. BOARD
	CONCRETE
	SECURED GYP. BOARD

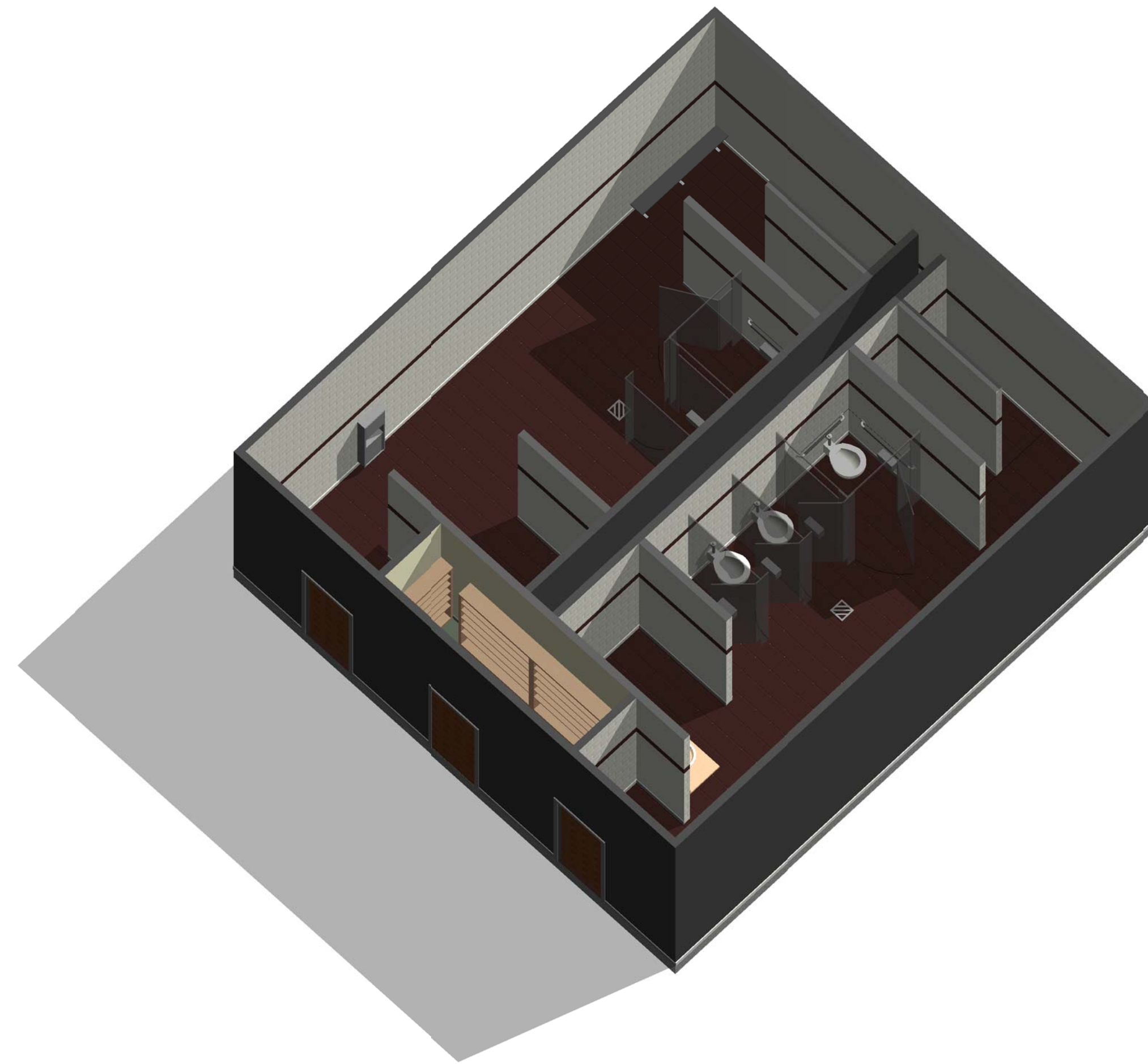

1 Module 9A - Back of House Restrooms - Axon.

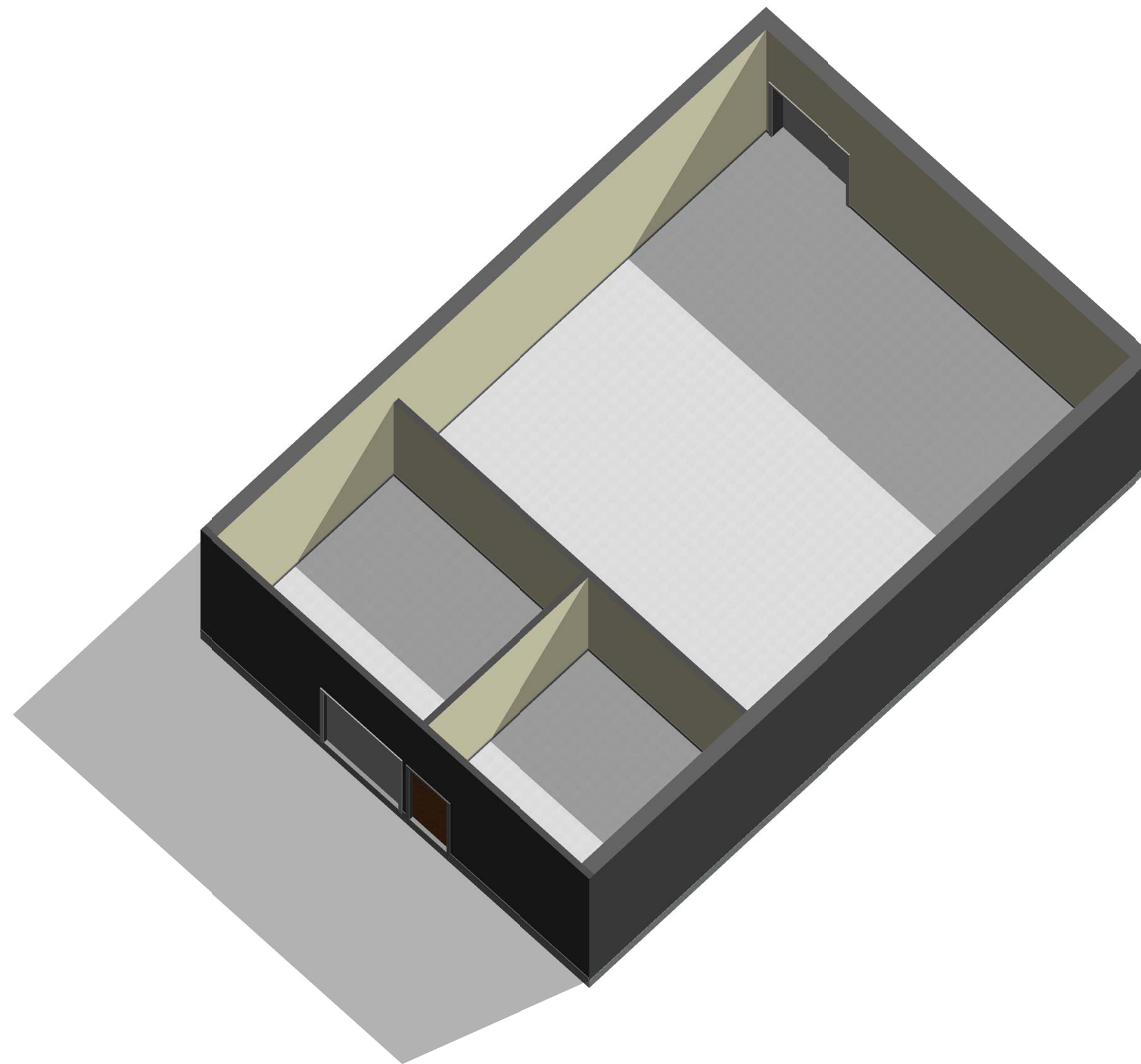

6 Module 9B - General Support - Axon.

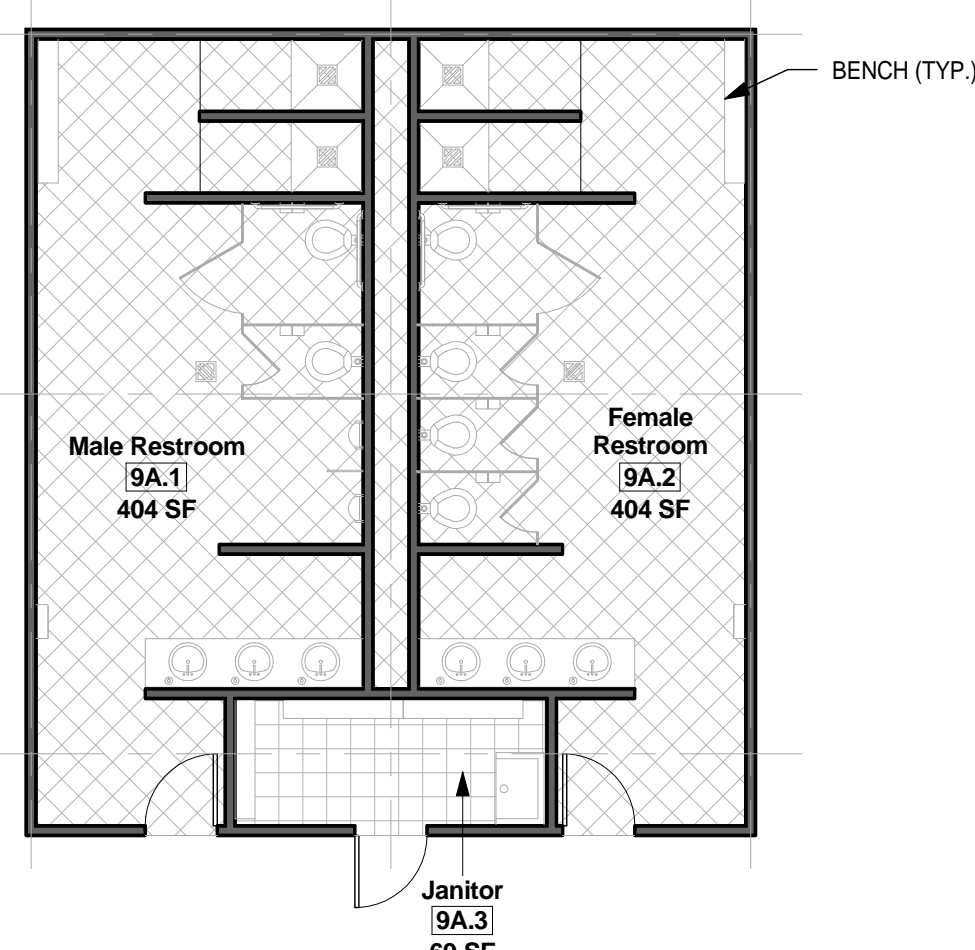

3 Module 9A - Back of House Restrooms - Floor Plan
1/8" = 1'-0"

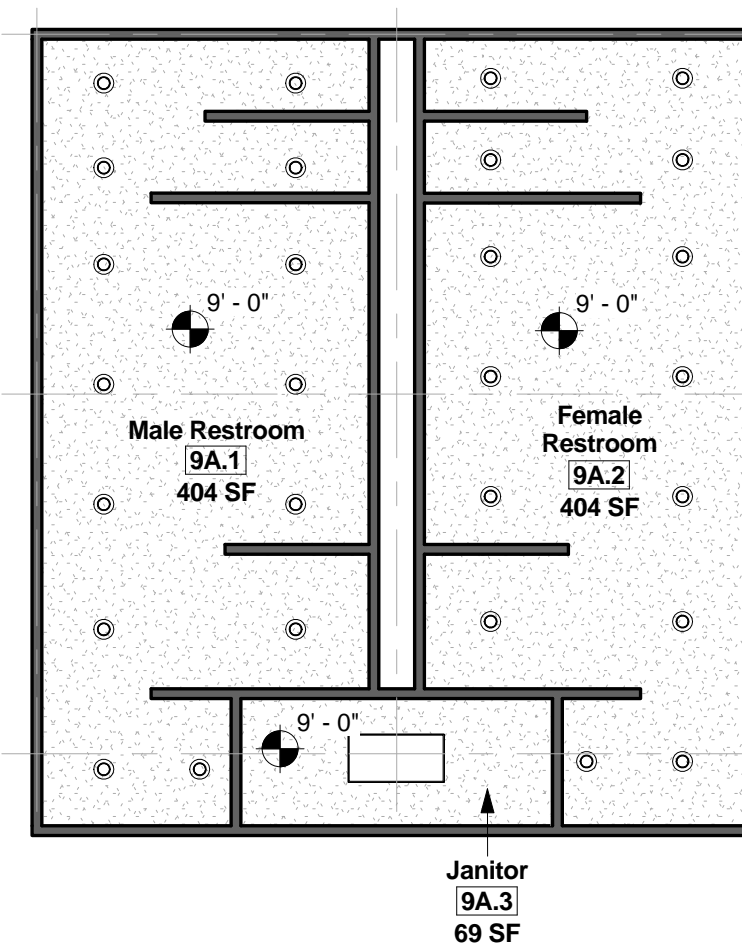

4 Module 9A - Back of House Restrooms - Reflected Ceiling Plan
1/8" = 1'-0"

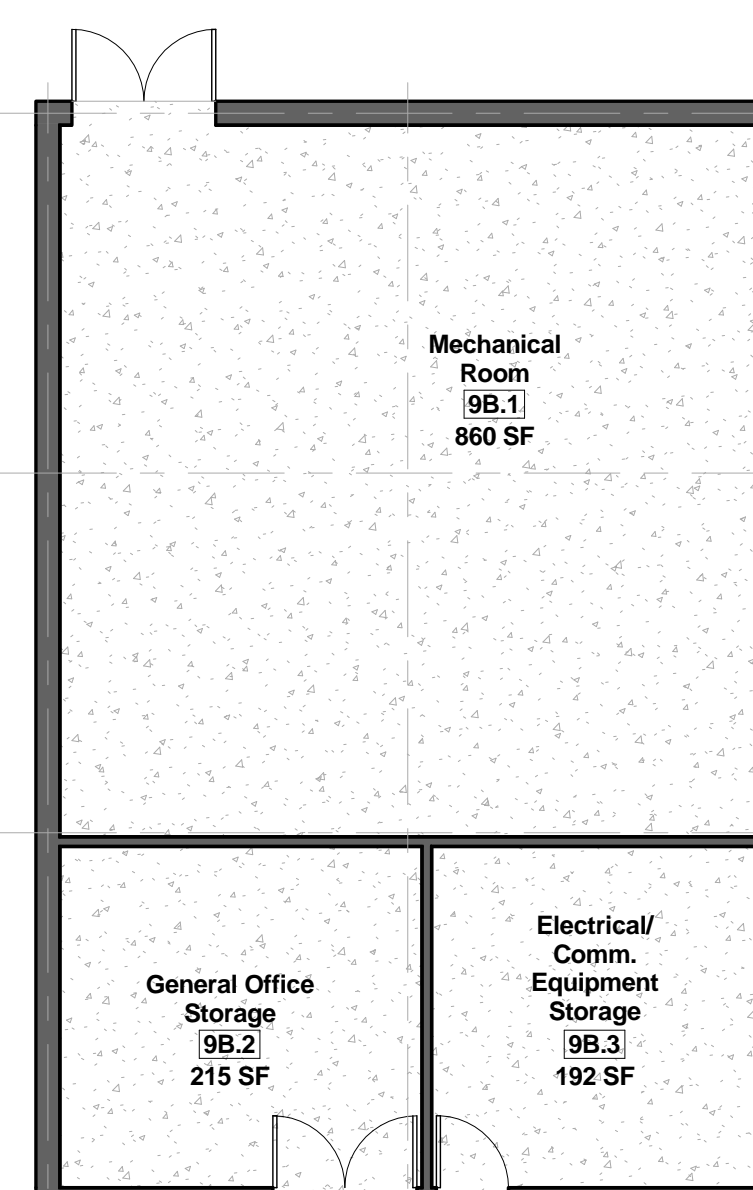

2 Module 9B - General Support - Floor Plan
1/8" = 1'-0"

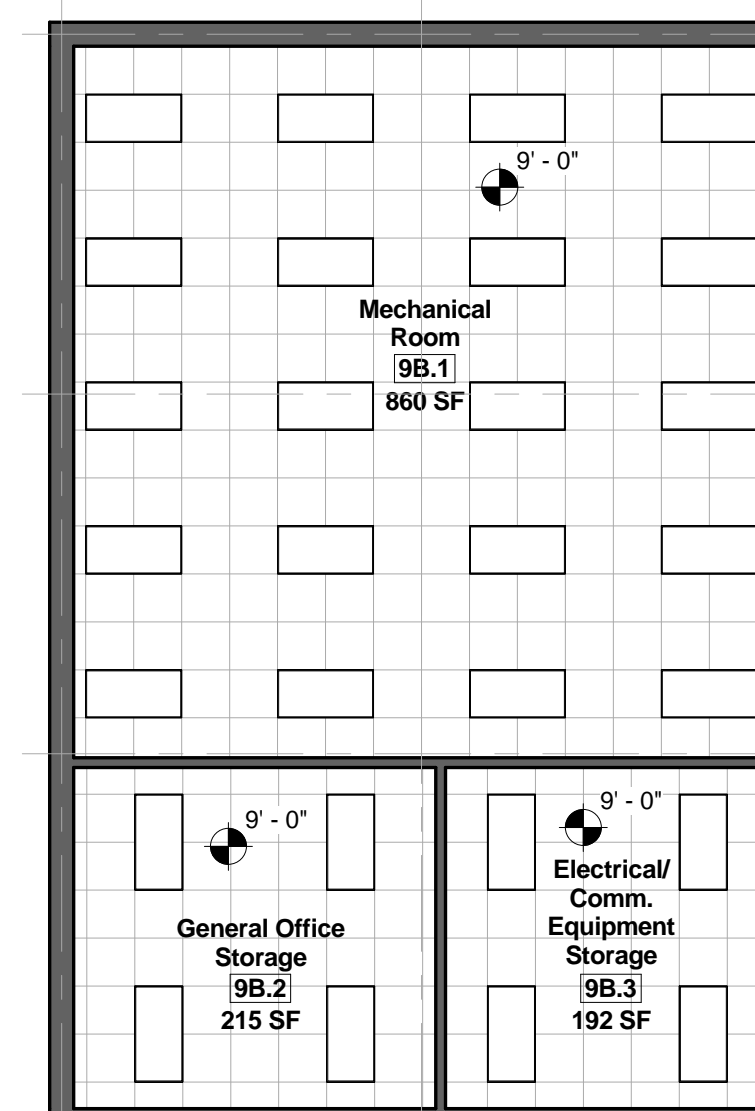

5 Module 9B - General Support - Reflected Ceiling Plan
1/8" = 1'-0"

**AIR FORCE CENTER FOR ENGINEERING AND
THE ENVIRONMENT (AFCEE)
FACILITIES DYNAMIC PROTOTYPES DESIGN FOR:
SECURITY FORCE OPERATIONS BUILDING
100% DESIGN**

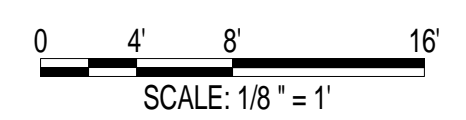

Jacobs Project No.: FDWD0262

Drawing Title:

**Back of House
Restrooms & General
Support**

Date: 18 NOVEMBER 2011

Designed By: JNMRB/OF Drawing No.:

Drawn By: JNMRB/OF

Checked By: JS





NOT FOR CONSTRUCTION

911 Central Parkway N., Suite 425 San Antonio, TX 78323
501 North Broadway, St. Louis, Missouri 63102-2121



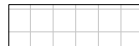

GENERAL NOTES

1. EVERY WALL IS GENERIC UNLESS SPECIFICALLY NOTED
2. EVERY WALL IS A PLACE HOLDER
3. AS THE MODULES ARE COMBINED TO CREATE A FACILITY, DISCRETION SHOULD BE USED AS TO WHICH WALLS NEED TO BE MOVED, ADDED OR REMOVED
4. IF NO WALL IS PRESENT, IT IS THE DESIGN INTENT TO LEAVE THAT SPACE OPEN TO ADJACENT SPACES WITHIN THE FACILITY
5. ALL FURNITURE IS A PLACE HOLDER UNLESS SPECIFICALLY NOTED
6. ALL MODULES HAVE BEEN ORGANIZED BASED ON A 15' GRID.

FLOOR FINISH LEGEND

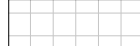
-  CARPET
-  EPOXY PAINT
-  SEALED CONCRETE
-  VCT TILE
-  CERAMIC TILE

CEILING LEGEND

-  2X2 ACOUSTICAL TILE
-  PAINTED GYP. BOARD
-  CONCRETE
-  SECURED GYP. BOARD

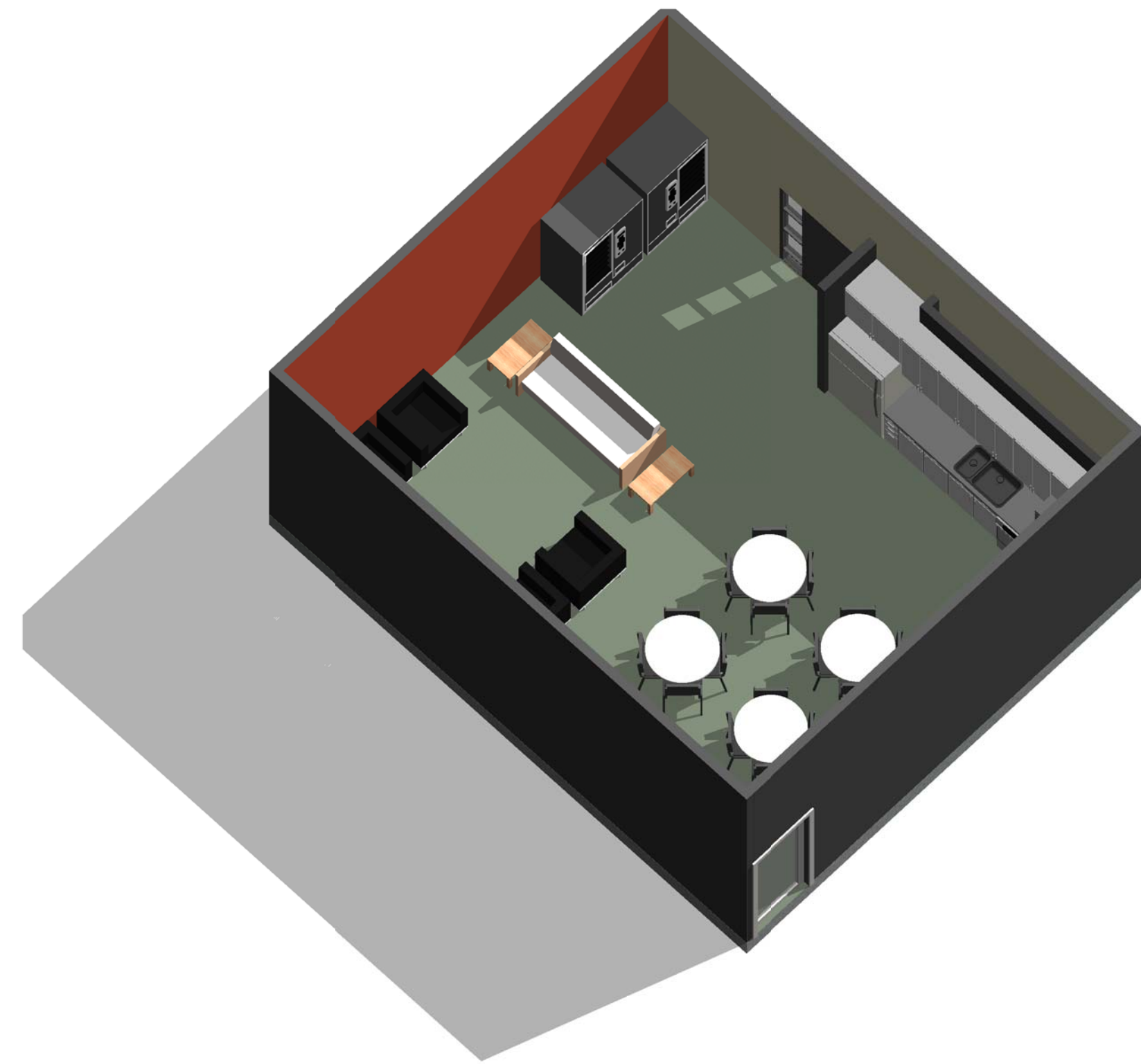

3 Module 9C - Break Room - Axon.

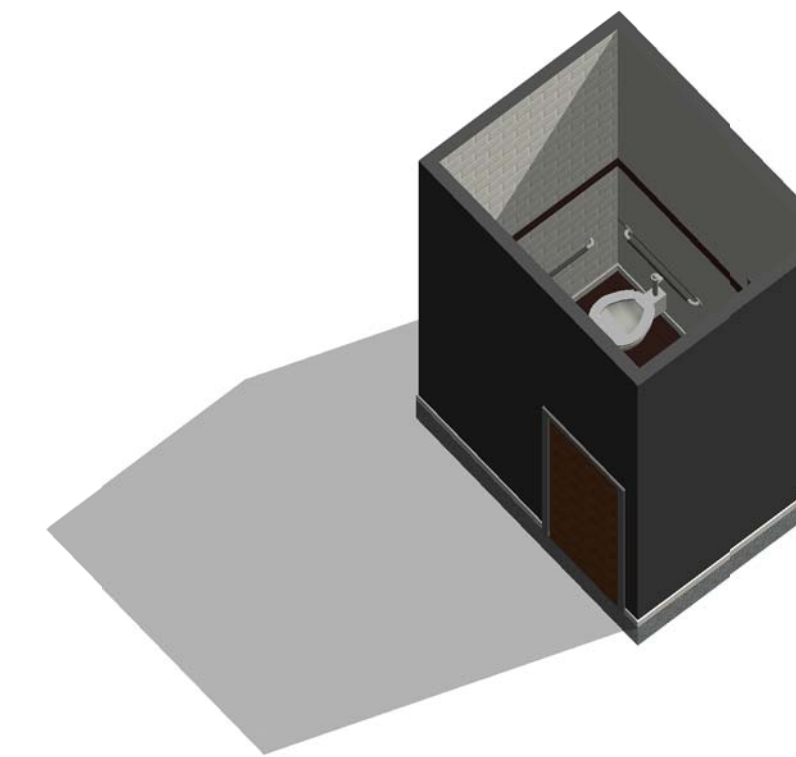

6 Module 9D - Front of House Restrooms - Axon.

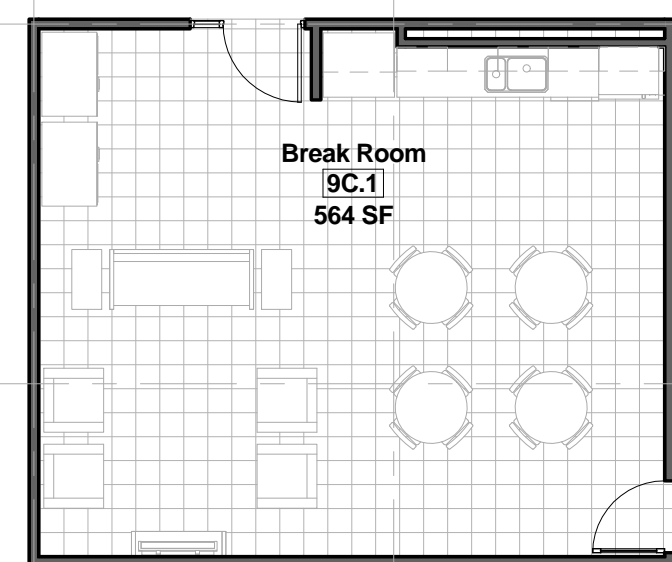

2 Module 9C - Break Room - Floor Plan
1/8" = 1'-0"

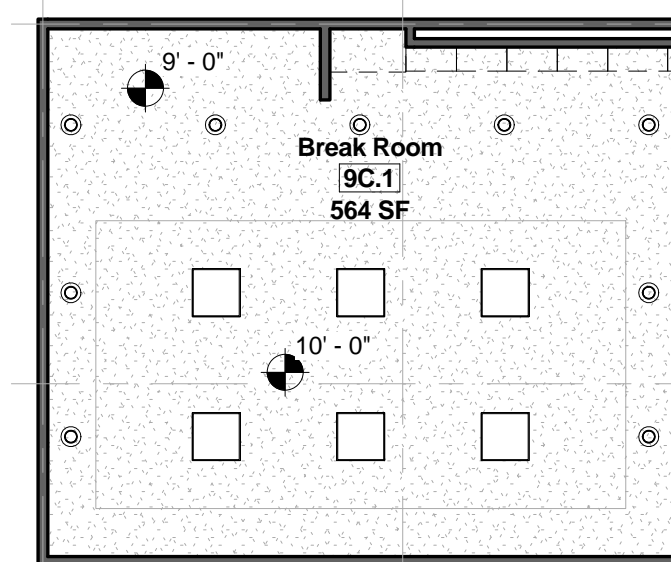

4 Module 9C - Break Room - Reflected Ceiling Plan
1/8" = 1'-0"

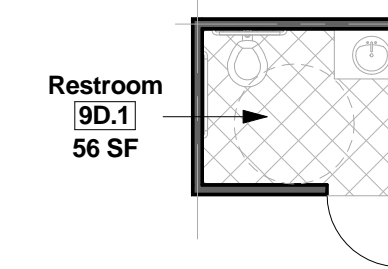

1 Module 9D - Front of House Restrooms - Floor Plan
1/8" = 1'-0"

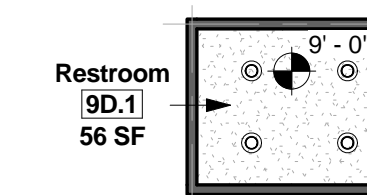

5 Module 9D - Front of House Restrooms - Reflected Ceiling Plan
1/8" = 1'-0"

**AIR FORCE CENTER FOR ENGINEERING AND THE ENVIRONMENT (AFCEE)
FACILITIES DYNAMIC PROTOTYPES DESIGN FOR:
SECURITY FORCE OPERATIONS BUILDING
100% DESIGN**

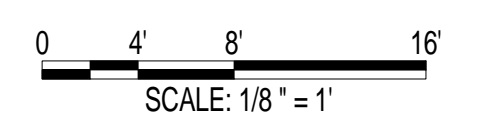

Jacobs Project No.: FDWD0262

Drawing Title:

Break Room & Front of House Restrooms

Date: 18 NOVEMBER 2011

Designed By: JNMRB/OF Drawing No.:

Drawn By: JNMRB/OF

Checked By: JS

A-110





**NOT FOR
CONSTRUCTION**

911 Central Parkway N., Suite 425 San Antonio, TX 78323
501 North Broadway, St. Louis, Missouri 63102-2121



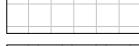

GENERAL NOTES

1. EVERY WALL IS GENERIC UNLESS SPECIFICALLY NOTED
2. EVERY WALL IS A PLACE HOLDER
3. AS THE MODULES ARE COMBINED TO CREATE A FACILITY, DISCRETION SHOULD BE USED AS TO WHICH WALLS NEED TO BE MOVED, ADDED OR REMOVED
4. IF NO WALL IS PRESENT, IT IS THE DESIGN INTENT TO LEAVE THAT SPACE OPEN TO ADJACENT SPACES WITHIN THE FACILITY
5. ALL FURNITURE IS A PLACE HOLDER UNLESS SPECIFICALLY NOTED
6. ALL MODULES HAVE BEEN ORGANIZED BASED ON A 15' GRID.

FLOOR FINISH LEGEND

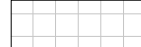
-  CARPET
-  EPOXY PAINT
-  SEALED CONCRETE
-  VCT TILE
-  CERAMIC TILE

CEILING LEGEND

-  2X2 ACOUSTICAL TILE
-  PAINTED GYP. BOARD
-  CONCRETE
-  SECURED GYP. BOARD

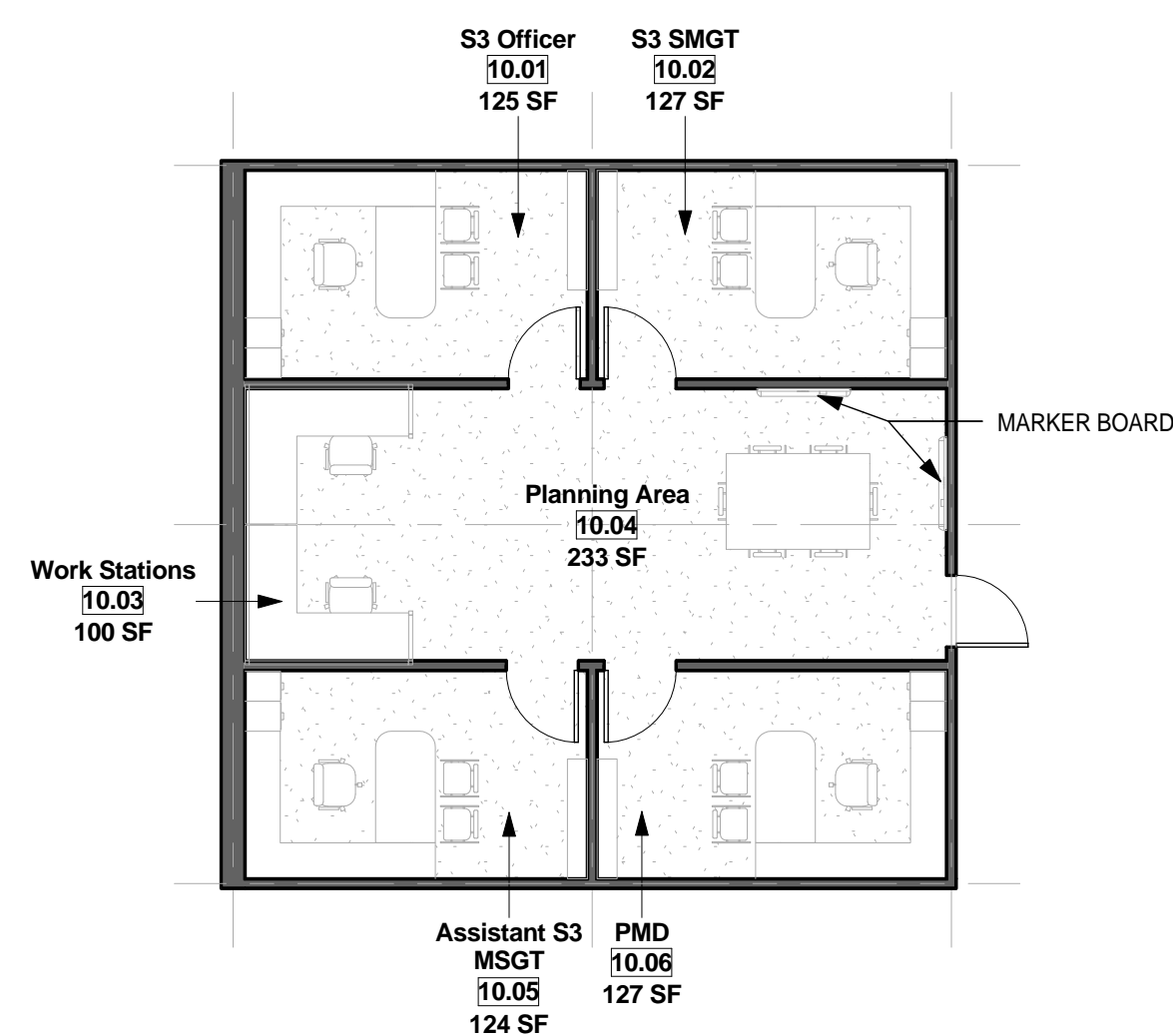

① Module 10 - Operations & Training/ S3
1/8" = 1'-0"



③ Module 10 - Operations & Training/ S3 - Axon.

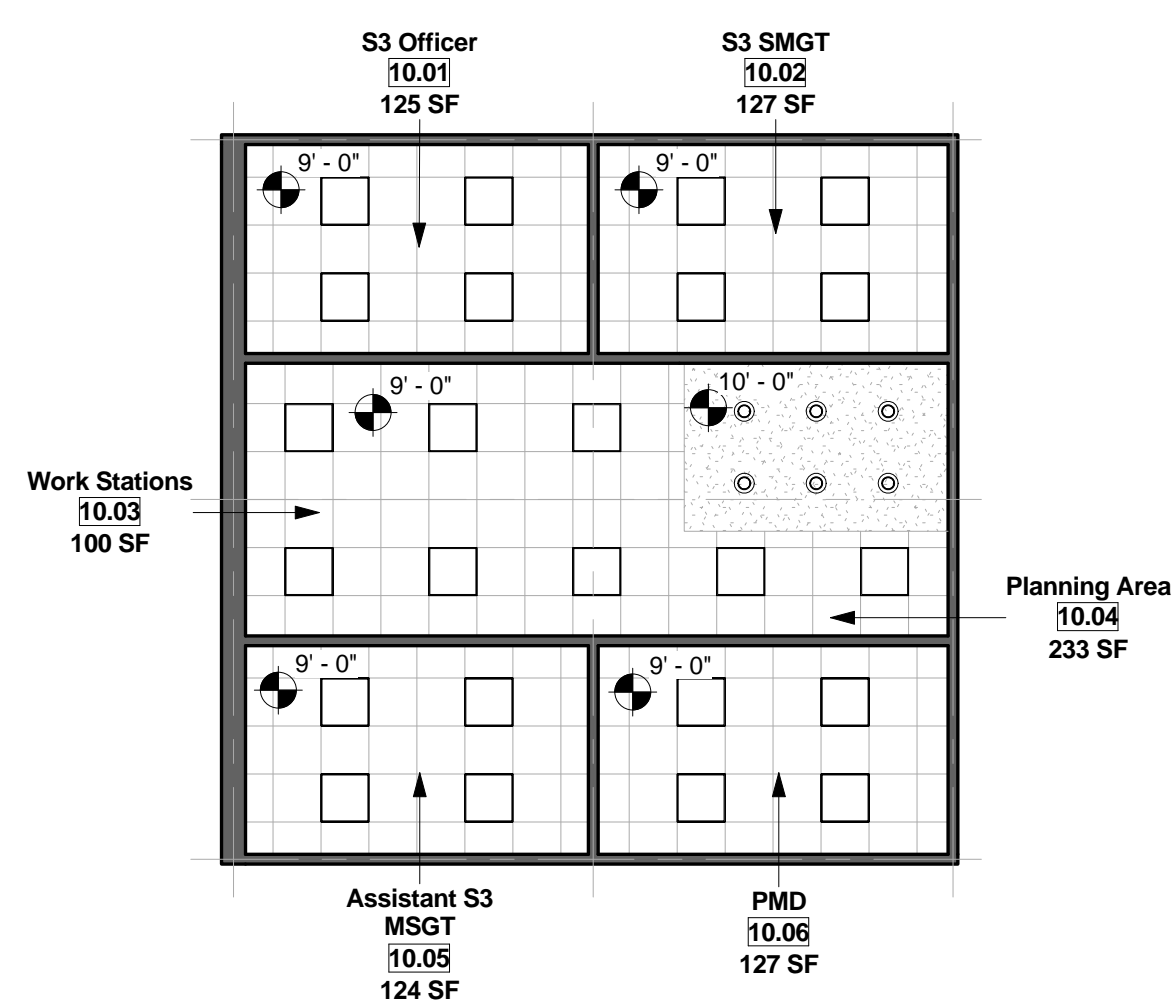

② Module 10 - Operations & Training - Reflected Ceiling Plan
1/8" = 1'-0"

**AIR FORCE CENTER FOR ENGINEERING AND
THE ENVIRONMENT (AFCEE)
FACILITIES DYNAMIC PROTOTYPES DESIGN FOR:
SECURITY FORCE OPERATIONS BUILDING
100% DESIGN**



Jacobs Project No.: FDWD0262

Drawing Title:

**Operations & Training/
S3**

Date: 18 NOVEMBER 2011

Designed By: JNM/RB/OF Drawing No.:

Drawn By: JNM/RB/OF

Checked By: JS

A-111

**NOT FOR
CONSTRUCTION**

911 Central Parkway N., Suite 425 San Antonio, TX 78223
501 North Broadway, St. Louis, Missouri 63102-2121

BUILDING NOTES

1. THIS BUILDING LAYOUT IS PROVIDED TO ILLUSTRATE ONE POSSIBLE WAY OF ARRANGING THE INDIVIDUAL MODULES. IT IS NOT INTENDED TO CONSTITUTE A FINAL DESIGN.



**AIR FORCE CENTER FOR ENGINEERING AND
THE ENVIRONMENT (AFCEE)
FACILITIES DYNAMIC PROTOTYPES DESIGN FOR:
SECURITY FORCE OPERATIONS BUILDING
100% DESIGN**

Jacobs Project No.: FDWD0262

Drawing Title:

**Building Rendering 1 -
Rendering**

Date: 18 NOVEMBER 2011

Designed By: JNM/RB/OF Drawing No.:

Drawn By: JNM/RB/OF

Checked By: JS

A-201

INDIVIDUAL MODULES

SCALE(S) AS NOTED ON THIS SHEET ARE BASED ON A FULL 36"X24" SIZE SHEET

NOT FOR CONSTRUCTION

911 Central Parkway N., Suite 425 San Antonio, TX 78323
501 North Broadway, St. Louis, Missouri 63102-2121

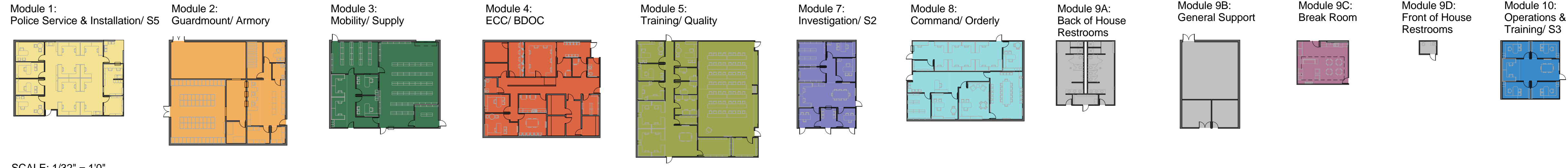

SCALE: 1/32" = 1'0"

D
C
B
A



AIR FORCE CENTER FOR ENGINEERING AND THE ENVIRONMENT (AFCEE)
FACILITIES DYNAMIC PROTOTYPES DESIGN FOR:
SECURITY FORCE OPERATIONS BUILDING
100% DESIGN

0 8' 16' 32' 64'
SCALE: 1/32" = 1'

0 4' 8' 16'
SCALE: 1/8" = 1'

Jacobs Project No.: FDWD0262

Drawing Title:

Building Example 1 - Floor Plan

Date: 18 NOVEMBER 2011

Designed By: JNM/RB/OF Drawing No.:

Drawn By: JNM/RB/OF

Checked By: JS A-202

BUILDING NOTES

- THIS BUILDING LAYOUT IS PROVIDED TO ILLUSTRATE ONE POSSIBLE WAY OF ARRANGING THE INDIVIDUAL MODULES. IT IS NOT INTENDED TO CONSTITUTE A FINAL DESIGN.

① Building Example 1 - Floor Plan
1/8" = 1'-0"

**NOT FOR
CONSTRUCTION**

911 Central Parkway N., Suite 425 San Antonio, TX 78323
501 North Broadway, St. Louis, Missouri 63102-2121

BUILDING NOTES

1. THIS BUILDING LAYOUT IS PROVIDED TO ILLUSTRATE ONE POSSIBLE WAY OF ARRANGING THE INDIVIDUAL MODULES. IT IS NOT INTENDED TO CONSTITUTE A FINAL DESIGN.



AIR FORCE CENTER FOR ENGINEERING AND
THE ENVIRONMENT (AFCEE)
FACILITIES DYNAMIC PROTOTYPES DESIGN FOR:
SECURITY FORCE OPERATIONS BUILDING
100% DESIGN

Jacobs Project No.: FDWD0262

Drawing Title:

**Building Example 2 -
Rendering**

Date: 18 NOVEMBER 2011

Designed By: JNM/RB/OF Drawing No.:

Drawn By: JNM/RB/OF

Checked By: JS

A-203

INDIVIDUAL MODULES

SCALE(S) AS NOTED ON THIS SHEET ARE BASED ON A FULL 36"x24" SIZE SHEET

NOT FOR CONSTRUCTION

911 Central Parkway N., Suite 425 San Antonio, TX 78323
501 North Broadway, St. Louis, Missouri 63102-2121

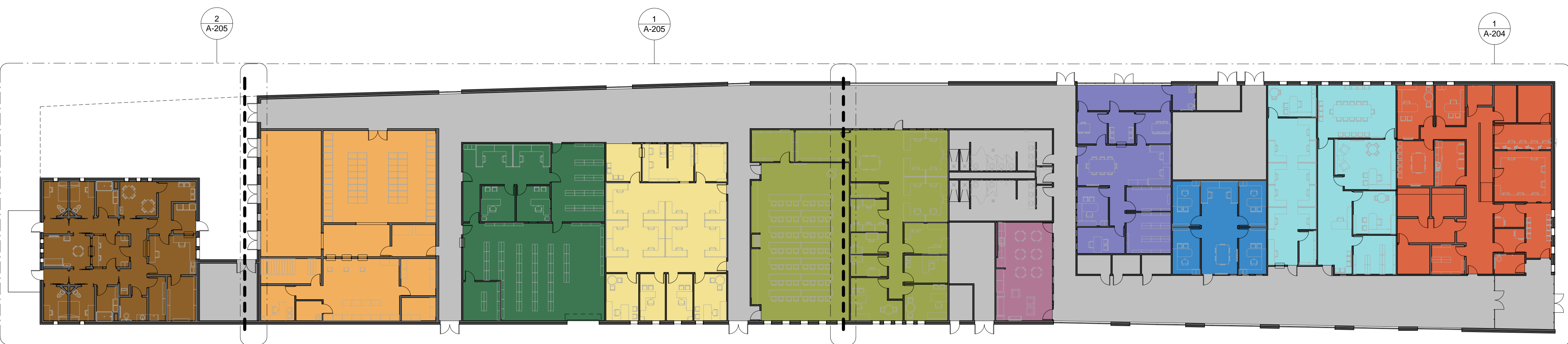

BUILDING NOTES

- THIS BUILDING LAYOUT IS PROVIDED TO ILLUSTRATE ONE POSSIBLE WAY OF ARRANGING THE INDIVIDUAL MODULES. IT IS NOT INTENDED TO CONSTITUTE A FINAL DESIGN.

3 Building Example 2
1" = 20'-0"



AIR FORCE CENTER FOR ENGINEERING AND THE ENVIRONMENT (AFCEE)
FACILITIES DYNAMIC PROTOTYPES DESIGN FOR:
SECURITY FORCE OPERATIONS BUILDING
100% DESIGN

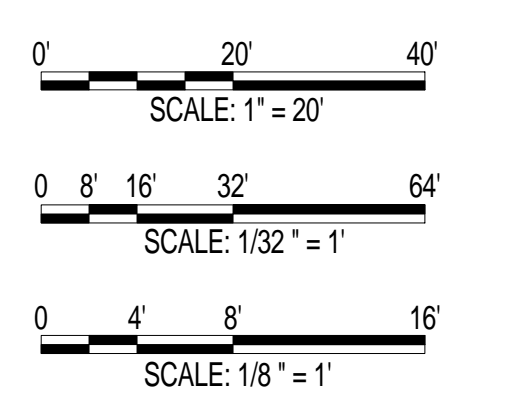

Jacobs Project No.: FDWD0262

Drawing Title:

Building Example 2 - Floor Plan

Date: 18 NOVEMBER 2011

Designed By: JNM/RB/OF Drawing No.:

Drawn By: JNM/RB/OF

Checked By: JS

A-204

1 Building Example 2 - Enlarged Floor Plan A
1/8" = 1'-0"

NOT FOR CONSTRUCTION

911 Central Parkway N., Suite 425 San Antonio, TX 78323
501 North Broadway, St. Louis, Missouri 63102-2121

BUILDING NOTES

- THIS BUILDING LAYOUT IS PROVIDED TO ILLUSTRATE ONE POSSIBLE WAY OF ARRANGING THE INDIVIDUAL MODULES. IT IS NOT INTENDED TO CONSTITUTE A FINAL DESIGN.

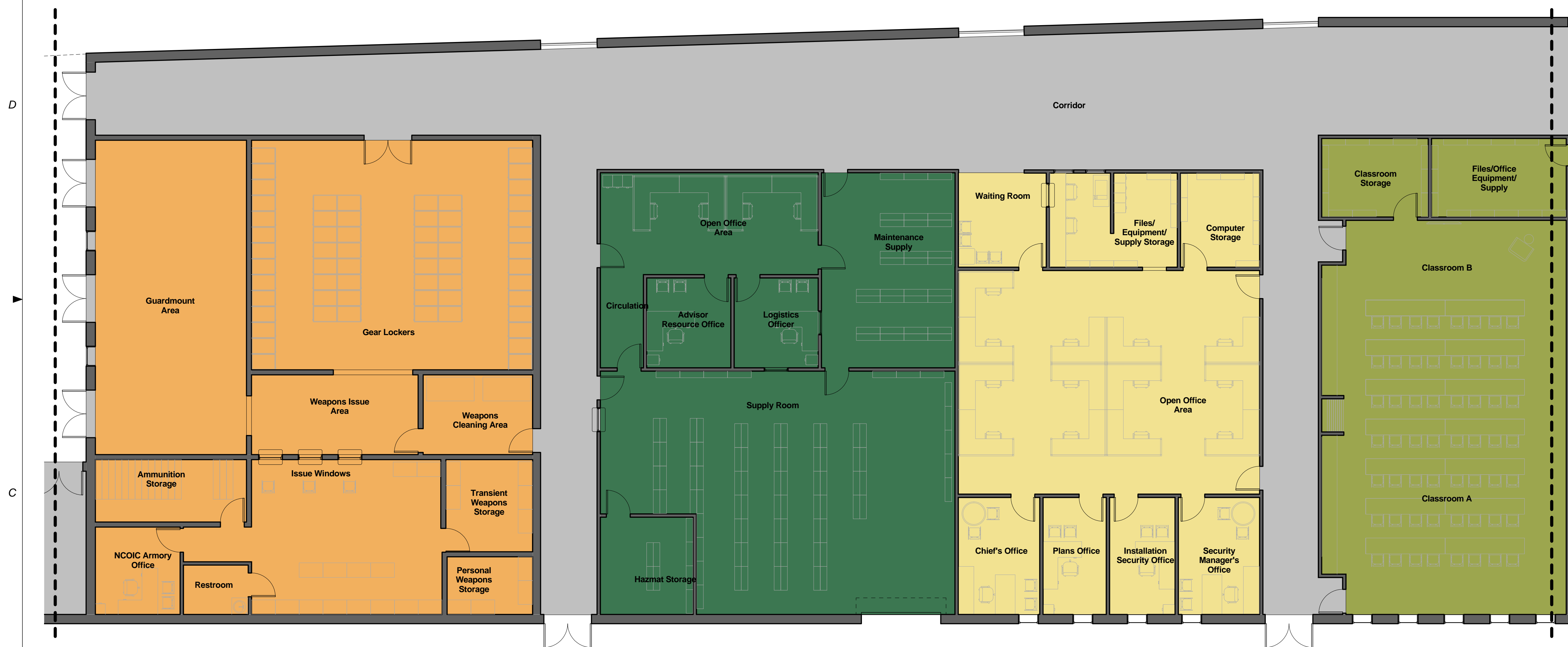

① Building Example 2 - Enlarged Floor Plan B
1/8" = 1'-0"

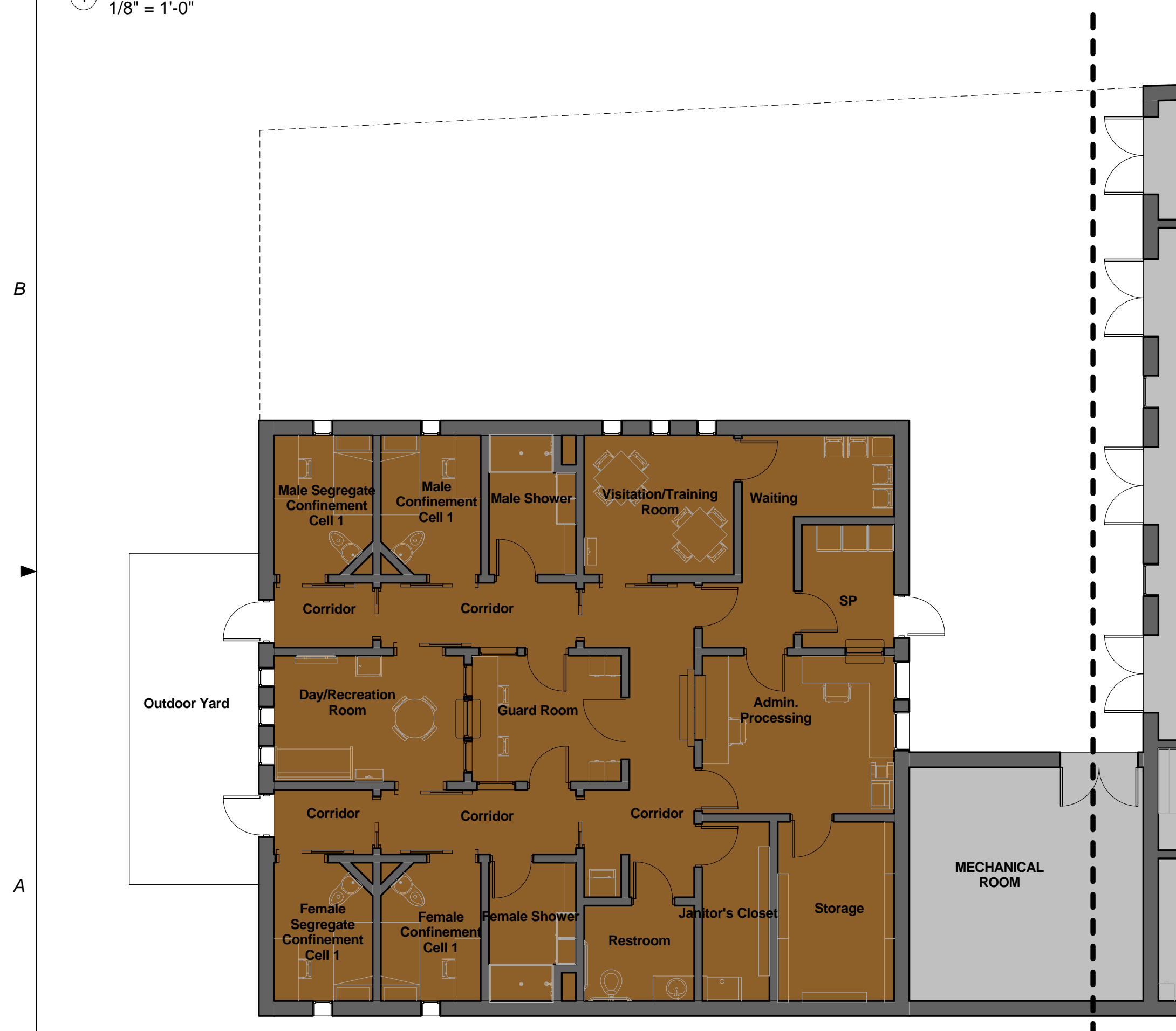

② Building Example 2 - Enlarged Floor Plan C
1/8" = 1'-0"

AIR FORCE CENTER FOR ENGINEERING AND
THE ENVIRONMENT (AFCEE)
FACILITIES DYNAMIC PROTOTYPES DESIGN FOR:
SECURITY FORCE OPERATIONS BUILDING
100% DESIGN

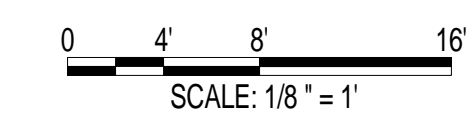

Jacobs Project No.: FDWD0262

Drawing Title:

**Building Example 2 -
Floor Plan**

Date: 18 NOVEMBER 2011

Designed By: JNM/RB/OF Drawing No.:

Drawn By: JNM/RB/OF

Checked By: JS

A-205

NOT FOR
CONSTRUCTION

911 Central Parkway N., Suite 425 San Antonio, TX 78323
501 North Broadway, St. Louis, Missouri 63102-2121

AIR FORCE CENTER FOR ENGINEERING AND
THE ENVIRONMENT (AFCEE)
FACILITIES DYNAMIC PROTOTYPES DESIGN FOR:
SECURITY FORCE OPERATIONS BUILDING
100% DESIGN

WINDOW SCHEDULE														
Mark	R.O.		Type	Manufacturer	Model	Material	Finish	Head	Jamb	Sill	Glazing		Head Height	Comments
	Width	Height									Thickness	Type		
1.06A	3' - 0"	4' - 0"	Pass Drawer and Counter										7' - 0"	
2.08A	3' - 0"	4' - 0"	Pass Drawer and Counter										7' - 0"	
2.08B	3' - 0"	4' - 0"	Pass Drawer and Counter										7' - 0"	
2.08C	3' - 0"	4' - 0"	Pass Drawer and Counter										7' - 0"	
3.03A	3' - 0"	4' - 0"	Fixed										7' - 0"	
3.03B	3' - 0"	4' - 0"	Fixed										7' - 0"	
3.04A	3' - 0"	4' - 0"	Pass Drawer and Counter										7' - 0"	
4.03A	3' - 0"	4' - 0"	Fixed										7' - 0"	
4.03B	3' - 0"	4' - 0"	Fixed										7' - 0"	
4.04A	3' - 0"	4' - 0"	Fixed										7' - 0"	
4.04B	3' - 0"	4' - 0"	Fixed										7' - 0"	
6.03A	3' - 0"	4' - 0"	Pass Drawer and Counter										7' - 0"	
6.03B	5' - 0"	3' - 6"	Roll-Up Shutter with Counter										7' - 0"	
6.03C	3' - 0"	4' - 0"	Fixed										7' - 0"	
6.03D	3' - 0"	4' - 0"	Fixed										7' - 0"	
6.08A	1' - 6"	4' - 0"	Fixed										7' - 0"	
6.09A	1' - 6"	4' - 0"	Fixed										7' - 0"	
6.10A	1' - 6"	4' - 0"	Fixed										7' - 0"	
6.11A	1' - 6"	4' - 0"	Fixed										7' - 0"	
6.13A	1' - 6"	4' - 0"	Fixed										7' - 0"	
6.13B	1' - 6"	4' - 0"	Fixed										7' - 0"	
6.13C	1' - 6"	4' - 0"	Fixed										7' - 0"	
6.15A	3' - 0"	4' - 0"	Fixed										7' - 0"	
6.15B	2' - 6"	4' - 0"	Fixed										7' - 0"	
6.15C	3' - 0"	4' - 0"	Pass Drawer and Counter										7' - 0"	
6.15D	2' - 6"	4' - 0"	Fixed										7' - 0"	
6.15E	3' - 0"	4' - 0"	Fixed										7' - 0"	
6.16A	3' - 0"	1' - 6"	Transom with Trim										7' - 6"	
6.16B	3' - 0"	1' - 6"	Transom with Trim										7' - 0"	
6.16C	3' - 0"	1' - 6"	Transom with Trim										7' - 0"	
7.06A	3' - 0"	4' - 0"	Pass Drawer and Counter										7' - 0"	
8.02A	3' - 0"	4' - 0"	Pass Drawer and Counter										7' - 0"	

Jacobs Project No.: FDWD0262

Drawing Title:

Window Schedule

Date: 18 NOVEMBER 2011

Designed By: JNMRB/OF Drawing No.:

Drawn By: JNMRB/OF

Checked By: JS

A-304